

Product Handbook

PD00E00KNX	KNX PRESENCE DETECTOR BASIC
PD00E01KNX	KNX PRESENCE DETECTOR STANDARD WITH LIGHTING CONTROL
PD00E02KNX	KNX PRESENCE DETECTOR MULTISENSOR - LIGHTING CONTROL, TEMPERATURE, HUMIDITY, SOUND SENSOR
PD00E03KNX	KNX PRESENCE DETECTOR MULTISENSOR - LIGHTING CONTROL, TEMPERATURE, HUMIDITY, SOUND SENSOR - OCCUPANCY AND UTILIZATION REPORTING
PD00E09KNX	KNX HIGH BAY PRESENCE DETECTOR WITH LIGHTING CONTROL

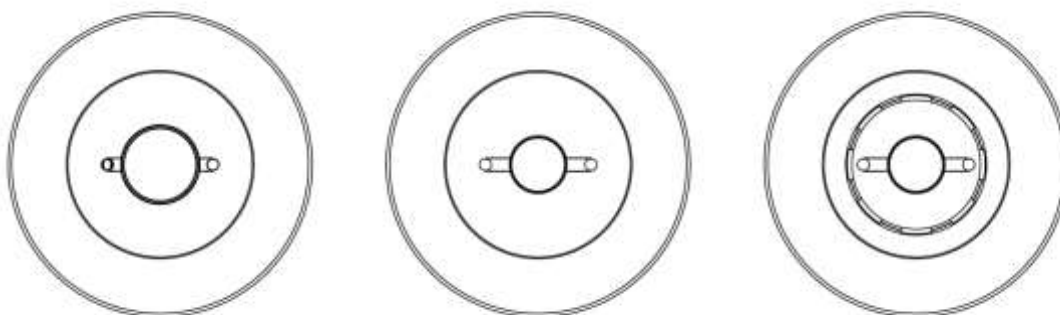

Document
 Version: 1.1
 Data: 03/06/2020

INDEX

1.	Introduction.....	5
2.	PRODUCT OVERVIEW.....	5
3.	Installation instructions.....	7
	Warning.....	7
	Hints.....	7
4.	General parameters.....	8
5.	Test Mode.....	8
	Description and execution of the test.....	8
6.	Presence Module.....	9
	Follow up time.....	9
7.	Illuminance module.....	9
	Adjustment of the illuminance sensor.....	9
	Manual adjustment.....	9
	1 point adjustment.....	10
	2 points adjustment.....	10
8.	Remote presence.....	11
9.	Use of remote presence.....	11
10.	Remote illuminance.....	11
11.	Use of remote illuminance.....	12
12.	Sound sensor.....	13
13.	Channels configuration.....	14
	Follow-up time.....	14
	Objects A,B,C - presence/absence.....	14
	Stand-by function (corridor function).....	15
	Lock function.....	15
	Stop function.....	16
	Utilization function.....	16
	Occupancy FUNCTION.....	17
	Simple presence.....	17
	Automatic presence, illuminance depending.....	17
	Semi-automatic presence.....	18
	Semi-automatic presence illuminance depending.....	18
	Constant illuminance.....	18
	Constant illuminance presence depending.....	19
	Constant illuminance presence depending, semi-automatic.....	19
14.	Digital input.....	19
	Activation on press (closing contact).....	19
	Activation on press / release (closing / opening contact).....	20
	Activation on short and long press.....	20
	Dimming.....	20
	Shutter and Blinds.....	20
	Scene.....	21
	Commands sequences.....	21
	Commands sequences (1 bit).....	21
	Set RGB color.....	22
	MUR / DND.....	22
	Loop among values.....	22
15.	Analog input.....	22
	Additional probe – description.....	23
	Additional probe – parameters.....	23
16.	Temperature sensor.....	23
	KNX probe.....	23
17.	Thermostat.....	24
	Setpoint Settings.....	24
	SETPOINT Object.....	24
	HVAC MODE obj. (switched heat / cool).....	24
	HVAC MODE obj. (automatic heat / cool).....	24
	SETPOINT COMFORT, STANDBY, ECONOMY.....	25
	COMFORT Object.....	25

Object ENABLE HEATING/COOLING.....	26
Object LOCK HEAT/COOL	26
WINDOW CONTACT Object	26
Object THERMOSTAT OFF	26
SETPOINT ADJUSTMENT object.....	26
ACTUAL SETPOINT object	26
Two points on/off.....	26
Integral proportional control PWM	27
Integral proportional contr. continuous.....	27
Fan coil on/off.....	27
Manage valve independently	28
Fan coil control PI.....	29
Additional valve.....	29
Additional valve 6 ways.....	29
Force fan coil speed.....	30
Ventilation mode.....	30
Temperature probe failure / out of range measurement	30
Temperature alarm object.....	30
18. Thermostat behavior on bus failure, recovery and download	31
Behavior on bus voltage failure	31
Behavior on bus voltage recovery.....	31
Behaviour on ETS Download	31
Wrong application download.....	31
19. Logics.....	31
20. Circadian rhythm function.....	33
Set color temperature	34
Set brightness.....	35
21. Virtual holder	35
How it works.....	35
Communication Objects.....	35
Parameters – General.....	35
Parameters – Remote inputs.....	36
Remote Sensor Inputs (Global Enable).....	36

Any information inside this manual can be changed without advice.

This handbook can be download freely from the website: www.eelectron.com

Exclusion of liability:

Despite checking that the contents of this document match the hardware and software, deviations cannot be completely excluded. We therefore cannot accept any liability for this.

Any necessary corrections will be incorporated into newer versions of this manual.

Symbol for relevant information



Symbol for warning



DISPOSAL: The crossed-out bin symbol on the equipment or packaging means the product must not be included with other general waste at the end of its working life. The user must take the worn product to a sorted waste centre, or return it to the retailer when purchasing a new one. An efficient sorted waste collection for the environmentally friendly disposal of the used device, or its subsequent recycling, helps avoid the potential negative effects on the environment and people's health, and encourages the re-use and/or recycling of the construction materials

1. Introduction

This manual is intended for use by KNX® installers and describes the functions and parameters of the KNX presence sensors "E" series and how it is possible to change the settings and configurations using the ETS software tool.

The range of Eelectron presence sensors is suitable for ceiling mounting and consists of 5 versions: 4 suitable for mounting up to 4 m in height and a version called "HIGH BAY" for installation up to 16 m height.

All versions have a rear connector with 3 digital inputs that can be connected to potential-free buttons or switches and used for on/off, dimming, roller shutters or blinds / scenarios, sequences, step-by-step commands, etc.

On STANDARD, MULTI, SPACE and HIGH BAY models one of the 3 inputs can be configured as analogical input for the connection of NTC temperature probes (see eelectron probes code TS00A01ACC / TS00B01ACC) with which is possible to send the temperature measurement on the bus or manage a complete thermostat module. The thermostat manages 2 stages with integrated PI controller for the control of heating and cooling equipment, valves, 2- and 4-pipe fan coils, etc.

CODE	TYPE	MAIN FUNCTIONS
PD00E00KNX	BASIC	PRESENCE DETECTION 3 DIGITAL INPUTS
PD00E01KNX	STANDARD	PRESENCE DETECTION LIGHTING CONTROL 2 DIGITAL INPUTS 1 ANALOG / DIGITAL INPUT
PD00E02KNX PD00E03KNX	MULTI SPACE	PRESENCE DETECTION LIGHTING CONTROL TEMPERATURE CONTROL [1] HUMIDITY SENSOR' SOUND SENSOR 2 DIGITAL INPUTS 1 ANALOG / DIGITAL INPUT / SMART SENSOR
PD00E09KNX	HIGH BAY	PRESENCE DETECTION LIGHTING CONTROL 2 DIGITAL INPUTS 1 ANALOG / DIGITAL INPUT

[1]: WITH EMBEDDED TEMPERATURE SENSOR.

The STANDARD, MULTI, SPACE and HIGH BAY versions include a brightness sensor for controlling ambient lighting, the MULTI and SPACE versions also include humidity and temperature sensors with relative control algorithms and a sound sensor that can be used in environments with parts not totally visible to the infrared sensor.

The humidity sensor (MULTI and SPACE models) can measure the relative humidity in the room and provide control with hysteresis of humidification and dehumidification devices; for this model of sensors it is possible to connect an accessory cod. SM03E01ACC

which allows to measure temperature and CO₂. The CO₂ measurement is available on the bus and from ETS it is possible to manage a threshold control with hysteresis for both on/off and proportional algorithm.

Presence detection, based on a passive infrared sensor, has 5 independent configurable channels with different functions that can be activated: presence with or without brightness control and with automatic or semi-automatic detection; constant brightness independent or dependent on presence and with automatic or semi-automatic activation. The BASIC sensor manages presence detection only.

There are 12 logic blocks with which is possible to create simple expressions with a logical or threshold operator or complex expressions with algebraic and conditional operators and also is possible to use predefined algorithms such as proportional controls of temperature and humidity or dew point calculation.

The device also integrates the "Virtual Holder" logic; the field of application is the hotel room: through a magnetic sensor installed on the door and connected to a digital input (also one of the sensor itself), accurate presence information is managed. The presence detection solution can recognize the presence of people in the room using one or more dedicated sensors. It also detects an unexpected presence and is able to differentiate multiple behaviors.

The device manages the ambient lighting based on the measured illuminance; it is also possible to enable the logic called "Circadian Rhythm" with which brightness and color temperature are imposed on the basis of predefined curves or on the basis of the real position of the sun during the day with respect to a terrestrial coordinates. This function allows you to recreate lighting comfort in an environment as close as possible to reality (STANDARD, MULTI, SPACE and HIGH BAY models).

The following mounting accessories are available:

CODE	FUNCTION
PD00E00ACC	SURFACE MOUNTING ENCLOSURE
PD00E01ACC	BOX MOUNTING FRAME

2. PRODUCT OVERVIEW

Functional modules of the device

The device includes some functional modules, below we list and describe those managed by the MULTI and SPACE sensor, some modules are not present in the models that do not include the brightness sensor (BASIC) and the temperature and humidity sensor (BASIC, STANDARD and HIGH BAY)

GENERAL PARAMETERS MODULE

Here some modules are enabled such as:

- Sound sensor
- Temperature control function
- Circadian rhythm
- Virtual holder
- Test mode

PRESENCE MODULE

Here are defined the parameters of the PIR sensor and its base module

- PIR sensor sensitivity
- Sensor follow-up time

ILLUMINANCE MODULE

Here the parameters referring to the light sensor are defined

- Adjustment method (calibration)
- Correction parameters
- Data sending parameters

REMOTE PRESENCE MODULE

Here up to 4 "slave" channels are enabled, it is possible to receive the presence detection data from other 4 sensors to better coordinate the control of areas that must be covered by multiple sensors.

REMOTE ILLUMINANCE MODULE

Here up to 4 "slave" channels are enabled, brightness data can be received from other 4 sensors to coordinate the control of areas that must be covered by multiple sensors. Each remote channel has its own correction parameters.

SOUND SENSOR MODULE

Here the parameters connected to the sound sensor are defined, such as the sensitivity and the telegram associated with its basic module.

MODULE CHANNEL CONFIGURATION

Here can be enabled up to 5 sensor channels. Each channel corresponds to a sensor behavior selectable from a list which includes:

- simple presence
- automatic presence illuminance depending
- semi-automatic presence
- semi-automatic presence illuminance depending
- Constant illuminance
- Constant illuminance presence depending
- Constant illuminance presence depending semi-automatic

INPUTS MODULE

Here, parameters and commands relating to digital and digital / analog inputs are set

HUMIDITY MODULE

Here the parameters and the regulation and hysteresis thresholds are set in order to control ambient humidity.

TEMPERATURE SENSOR/THERMOSTAT MODULE

Temperature control parameters and algorithms.

CIRCADIAN RHYTHM MODULE

Parameters relating to the management of the lighting control according to the circadian rhythm, logic for setting a forced cycle or a cycle that resumes the light behaviour in any terrestrial position and includes the management of warm and cold light.

VIRTUAL HOLDER MODULE

Parameters relating to the logic of automatic recognition of the presence of people in the room typically for hotel application

CONFIGURABLE SMART LOGICS

It includes 12 configurable logics that include algebraic and conditional expressions, the number of logics is reduced if the "virtual holder" or "circadian rhythm" or "smart sensor (CO₂)" modules are used.

Main functions digital inputs 1,2,3

Inputs can be connected to pushbuttons, switches, and can be used for:

- 1-bit commands: loads activation / deactivation commands (ON / OFF / TOGGLE) with short pressure or with long and short pressure differentiation
- 1 byte commands (0-255 or HVAC commands or % value commands).
- Sending long action telegrams to the same short action address or to a different group address
- Commands for cyclic sending
- Sequences (3 commands that mix 1 bit / 1 byte objects) with different group addresses - in short and long press mode or in switching mode
- Dimmer management (with single button or with double button)
- Roller shutters and blinds management (with single button or with double button)
- Control sequences with 1 bit to manage switching on / off lights or rows of lights
- RGB color setting with fixed value (short pressure) or color change (long pressure); 1 byte datapoint or 3 byte selectable
- MUR / DND (Make Up Room - / Do Not Disturb), function with built-in logics
- Loop function between values to send step by step a sequence of values of 1 byte

Main functions analog input 3

Input 3 can be configured as analog for the connection of NTC temperature probes (STANDARD, MULTI, SPACE and HIGH BAY) and also as a "smart sensor" input for reading temperature and CO₂ (MULTI and SPACE versions)

NTC probes:

For NTC temperature probe the following eelectron code accessories must be used:



TS01A01ACC (from -20°C to +100°C)
 TS01B01ACC (from -50°C to +60°C)

Slave sensors:

SM03E01ACC: this accessory includes a temperature sensor (range from -5 °C to + 50 °C) and a CO₂ sensor (range from 0 ppm to 1000 ppm).

SM03E02ACC: this accessory includes a temperature sensor (range from -5 °C to + 50 °C) and a VOC sensor for Indoor Air Quality (IAQ) and equivalent CO₂ (eCO₂) measurement.

Thermostat main functions

- Different Control Algorithms: 2-point on / off; PWM; continuous control / Fan Coil control
- Different modes of operation mode setting: Automatic HVAC / HVAC Manual / Setpoint
- Additional command for 2nd stage management
- Window contact management
- Additional external probe (optional)

Logics and “Virtual Holder” function

The device includes some logic functions and a logic for the automatic recognition of the presence called “Virtual Holder”

Logics – main functions

- Each logic has 2 input objects and 1 output object available
- Smart logics with complex expressions may use 4 input and 1 output objects
- Parameters: delay and number of retransmissions
- NOT / AND / OR / NAND / NOR / XOR / XNOR
- Bit to Byte conversion
- Byte to Bit conversion
- Threshold functions for 1,2,4 Bytes objects
- Logics to manage Fan coil speeds
- Logics to manage dew point calculation
- Logics to manage telegrams surveillance

3. Installation instructions

Warning

The device may be used for permanent indoor installations in dry locations within wall box mounts.



WARNING

- Device must be installed keeping a minimum distance of 4 mm between electrical power line (mains) and input cables or red / black bus cable.
- The device must not be connected to 230V cables
- The prevailing safety rules must be heeded.
- The device must be mounted and commissioned by an authorized installer.
- The applicable safety and accident prevention regulations must be observed.
- The device must not be opened. Any faulty devices should be returned to manufacturer.
- For planning and construction of electric installations, the relevant guidelines, regulations and standards of the respective country are to be considered.
- KNX bus allows you to remotely send commands to the system actuators. Always make sure that the execution of remote commands does not lead to hazardous situations, and that the user always has a warning about which commands can be activated remotely.

Hints



Illuminance measurement

Ambient illuminance measurement is performed indirectly, and calibration is therefore necessary. The sensor is installed on the ceiling and the detected illuminance can differ significantly from that of the work surface; using the SW ETS it is possible to set correction parameters for the device on the basis of an on-site measurement using a lux-meter. Do not allow sunlight or artificial light to directly irradiate the sensor.



Presence and movement detection

The sensor allows you to set different sensitivity levels; read with care the following notes for correct installation of the device and setting of the sensitivity parameters.

- The sensor detects the difference between the ambient temperature and the temperature of moving objects and people; the lower this temperature difference, the less sensitive the sensor will be.
- For a correct coverage of the sensor surveillance area, avoid that walls (including glass) or furniture are an obstacle; if this is not possible, increase the number of sensors in the area for complete coverage.
- Always mount the sensor on a stable site, not subject to vibrations or oscillations that can simulate movement.

- Lighting fixtures placed near the sensor or in the monitored area can cause false detections, avoid this type of interference as much as possible.
- Avoid placing in the coverage area there are appliances that produce heat such as fan coils, printers, lamps, etc. or objects that move because of the wind or drafts.

Please see datasheet at: www.eelectron.com

4. General parameters

PARAMETRO KNX	IMPOSTAZIONI
Delay to send telegrams on power up [s]	5 ÷ 15
Through this parameter is possible to set the delay of transmission of telegrams after a power on by selecting the time by which the device is allowed to send telegrams. In large systems after a power failure or shutdown this delay avoids generating excessive traffic on the bus, causing slow performance or a transmission block. If there are different devices requiring sending telegrams on the bus after a reset, these delays must be programmed to prevent traffic congestion during the initialization phase. The input detection and the values of objects are updated at the end of the transmission delay time. At the end of ETS programming the device behaves like after a power on.	
Sound sensor	disabled/enabled
Enabling the function shows the dedicated page	
Input 3 type	digital analog CO ₂ Sensor
Input 3 of the sensor can be configured as digital (for interfacing buttons) / analog (for interfacing NTC probes / CO ₂ sensor for interfacing the CO ₂ sensor code SM03E01ACC)	
Humidity sensor	disabled/enabled
Enabling the function shows the dedicated page	
Temperature function	Temperature function disabled Temperature sensor Thermostat
Temperature sensor: 2-point temperature control module with hysteresis, selection of the control band variable from the bus, enabling and disabling the module from the bus. Thermostat: complete temperature control module, PI algorithm, dedicated functions for on / off valve management - PWM - continuous - 6-way; fan coil, etc.	
Day/night Object	disabled/enabled
Using this object, it is possible to change the sensitivity of the sensor at different times of the day, for example by increasing the sensitivity during the day and decreasing it at night.	
Use CO₂ sensor	no/yes
By enabling this parameter, it will be possible to connect a smart sensor (temperature + CO ₂) cod. SM03E01ACC	
Use circadian rhythm	disabled/enabled
Enable the circadian rhythm module (see paragraph 20)	
Use virtual Holder	disabled/enabled
By setting this parameter, it is possible to enable a "virtual holder", that is a logical function that automatically recognizes the presence of a person in a room. This function can be used in hotels or similar installations and requires	

connection to other devices (see Virtual holder) (see paragraph 21)	
Use VOC sensor	no/yes
By enabling this parameter, it will be possible to connect a smart sensor (temperature + CO ₂) cod. SM03E02ACC	
Temperature alarm object	disabled/enabled
The "temperature alarm" object is used to report alarms relating to the sensor connected to input 3 (if enabled), to the smart sensor (if present), or if surveillance timeout occurs when KNX-Probe (via bus is enabled).	
Use led for presence event	no/yes
Defines whether the indicator LED is lit on to indicate presence detection	
Enable test mode	disabled/enabled
By enabling this parameter will be visible a communication object to enter test mode (see paragraph 5)	

5. Test Mode

Description and execution of the test

During installation it is recommended to put the sensor in test mode to check the actual coverage area. With the test it is possible to check whether the area controlled by the sensors includes, for example, the PC workstations rather than the expected entry points; similarly, it will be possible to verify that the monitored areas do not include unwanted passage areas such as corridors or stairs that would have the effect of activating lights or other appliances without the need for them. In both cases it is recommended to change the position of the sensor and repeat the test.

To activate the test, use the 1-bit object:

0 <General> Test Mode	1bit CW
Enables test mode when receiving a "1" telegram. The test mode is deactivated upon receipt of a "0" telegram or after a time that can be set in minutes using the "Test time" parameter visible on the "General Parameters" page.	

During the test, the front LED is always enabled, and its lighting indicates that a movement has been detected. During the test, the 1-bit telegram associated with the following object is also sent on the bus:

4 <Presence> Output	1bit CRT
On / Off object subordinated to the presence module	

If it is necessary for the sensor to detect "small" movements such as a person working on a desk, it is recommended to check the detection also in relation to the sensitivity value set. The higher the sensitivity set, the greater the sensor's ability to detect "small" movements. High sensitivity values can lead to false detections caused by "thermal noise": carefully read

the warnings to reduce the possibility of false detections. (see paragraph 3)

6. Presence Module

The presence module provides a parameter for setting the sensitivity of the PIR sensor, this parameter will also affect detection for channels 1 to 5 that use presence; the remaining parameters are connected only to this module.

KNX PARAMETER	SETTINGS
Sensor sensitivity	Very high sensitivity high sensitivity normal sensitivity low sensitivity very low sensitivity
Use low sensitivity values when the sensor is placed in "thermally noisy" environments, for example in the presence of sources of hot or cold air emissions (see installation suggestions); high sensitivity values can be used when the sensor must detect "small" movements such as those of a person working at a desk.	
Sensor sensitivity day	If the day-night switching object is enabled (general parameter), it will be possible to diversify the sensitivity at different times of the day
Sensor sensitivity night	
Presence sensor	send absence only send presence only send both absence/presence
For the basic module it defines in which cases to send the 1 bit telegram.	
Presence telegram	OFF is presence ON is presence
Defines the value of the 1-bit telegram per presence; the opposite value will be used for absence.	
Follow up time	0..24 0..59 0..59
Hours	
Minutes	
Seconds	0..59
Sets the follow up time	
Output cyclic send time	No cyclic sending 15 s ... 12 h
Set the period of cyclical sending.	

Follow up time

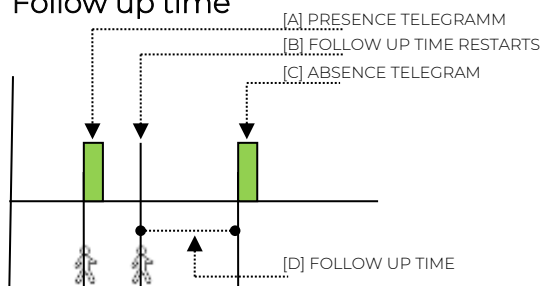

The presence telegram is sent in the presence module when the sensor detects presence [A]; the device waits for the follow up time to elapse before sending the absence telegram [C]; if a new movement [B] is detected during the monitoring time, the follow up time restarts. The absence telegram is sent only when the follow up time ends without any movement being detected [D]

7. Illuminance module

In this module the parameters relating to the brightness sensor are configured (not present on the model PD00E00KNX - BASIC).

Adjustment of the illuminance sensor

It is very important to carry out a correct and precise calibration of the illuminance sensor; in fact, the sensor must measure the illuminance on the desk but it's usually placed in a different position (on the ceiling). The sensor receives reflected light and the reflection depends on the reflective capacity of the floor or furniture and the distance from the windows.

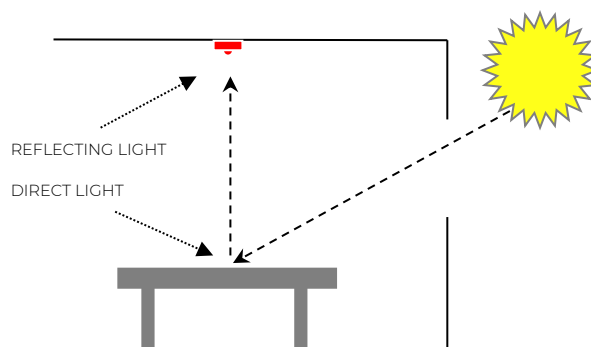

The calibration is to make the value of reflected light as similar as possible to direct light.

There are 3 calibration methods available.

- MANUAL
- 1 POINT
- 2 POINTS

Manual adjustment

Manual calibration is done by setting 2 ETS parameters:

KNX PARAMETER	SETTINGS
Correction coefficient [*0.01]	1 ... 1023

Set the factor, expressed in hundredths, to multiply by the measured value. The value 100 is equivalent to not applying any correction value; values greater than 100 cause the measured illuminance value to increase (200 = double, 250 = 2.5 times; 300 = triple); values less than 100 cause the measured brightness value to decrease (50 = half, 25 = a quarter, 10 = a tenth).

Correction offset [*10 Lux]	-128 ... +127
-----------------------------	---------------

Sets a fixed value to be added or subtracted from the measured value after applying the correction coefficient; the Offset value set is in tens of lux therefore setting the parameter to the value +10 will result in adding 100 Lux (10 * 10 = 100) to the measured value, on the contrary setting the parameter to the value -8 will result in that to subtract 80 Lux (-8 * 10 = -80) from the measured value. The value 0 is equivalent to not applying any offset.

1 point adjustment

The 1-point calibration uses the correction offset which is calculated directly by the sensor; requires setting of 2 ETS parameters:

KNX PARAMETER	SETTINGS
Measured value ceiling [*10 Lux]	0 .. 255
Measured value desk [*10 Lux]	0 .. 255

To set the correct values of the parameters, use a lux meter to detect the brightness and follow the procedure described below; if possible, carry out the procedure in the dark hours or with the shutters down, in any case avoid situations in which the external light enters the room directly because in this case the result could be distorted.

STEP	DESCRIPTION
1	Place the lux-meter on the work surface for which you want to have accurate brightness control,
2	Change the intensity of the lamps until the desired lighting value is obtained: if, for example, the desired value is 500 Lux, adjust the lighting until this measurement is obtained on the lux-meter located on the desk.
3	Read the brightness value measured by the sensor and available on object 8 <Illuminance> Output
4	Set in ETS the parameter " Measured value ceiling " with the value sent by the sensor (divided by 10) and the parameter " Measured value desk " with the value measured by the lux meter (divided by 10)

2 points adjustment

The 2-point calibration uses both the correction offset and the correction coefficient and both are calculated directly by the sensor; requires setting of 4 ETS parameters:

KNX PARAMETER	SETTINGS
Measured value ceiling PT1 [*10 Lux]	0 .. 255
Measured value desk PT1 [*10 Lux]	0 .. 255
Measured value ceiling PT2 [*10 Lux]	0 .. 255
Measured value desk PT2 [*10 Lux]	0 .. 255

To set the correct values of the parameters, use a lux meter to detect the brightness and follow the procedure described below; if possible, carry out the procedure in the dark hours or with the shutters down, in any case avoid situations in which the external light enters the room directly because in this case the result could be distorted.

STEP	DESCRIPTION
1	Place the lux-meter on the work surface for which you want to have accurate brightness control,
2	Change the brightness of the lamps until you get the lighting value lower than the desired one: if for example the desired value is 500 Lux, modulate the lighting up to read 100/200 Lux on the lux-meter placed on the desk.
3	Read the brightness value measured by the sensor and available on object 8 <Illuminance> Output
4	Set in ETS the parameter "Value measured on the ceiling PT1" with the value sent by the sensor (divided by 10) and the parameter "Value measured on the desk PT1" with the value measured by the lux-meter (divided by 10)
5	Change the brightness of the lamps until obtaining the lighting value higher than the desired one: considering a desired value of 500 Lux, modulate the lighting up to read 700/900 Lux on the lux meter placed on the work surface.
6	Read the brightness value measured by the sensor and available on object 8 <Illuminance> Output
7	Set in ETS the parameter "Value measured on the ceiling PT2" with the value sent by the sensor (divided by 10) and the parameter "Value measured on the desk PT2" with the value measured by the lux-meter (divided by 10)

KNX PARAMETER	SETTINGS
Average lux algorithm	Very fast fast normal slow very slow
Defines the response speed of the controlled output after a measured ambient brightness variation (see figure 1)	
Minimum output value [*10 Lux]	0 ... 255
Maximum output value [*100 Lux]	5 ... 255

Values below the minimum value will be forced to the minimum value, values greater than the maximum value will be forced to the maximum value,	
Send on variation [Lux]	Do not send, 5 .. 75
Minimum difference in the measurement in Lux compared to the previous value which triggers the immediate sending of the value	
Cyclic send time	No cyclic sending, 15 s .. 12 h
Period of cyclical sending of the illuminance measurement	

AVERAGE LUX CALCULATION ALGORITHM (Fig. 1)

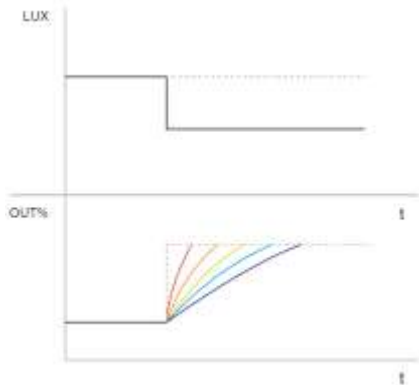

When there is a sudden change in illuminance (in the example the lux is reduced) the system reacts by increasing the control value%, the red slope corresponds to the "very fast" algorithm, the purple one (softer) corresponds the "very slow" algorithm.

8. Remote presence

The sensor can also receive presence information from other sensors (remote sensors) which therefore act as "slaves" of the main sensor acting as "master". The "slave" sensors are used to increase the detection area. When a sensor acts as a "slave" it can still also act as a "master" for the area it covers.

The settings relating to the management of the slaves can be set in the "Remote Presence" section. The device can receive up to 4 x 1-bit telegrams on 4 different addresses from "slave" sensors, for each "slave" it is possible to define whether presence is detected with telegram "0" or "1".

As will be seen later, in the section relating to the sensor channels, each channel can be a "master" of all the defined slaves or only a part of them; this allows to define complex behaviours.

For example: in an area covered by 5 sensors the "master", to which 4 "slaves" are connected, is able to regulate a group of lights which must be turned on when at least one slave detects the presence while other 5 groups of lights can be each associated with a single sensor.

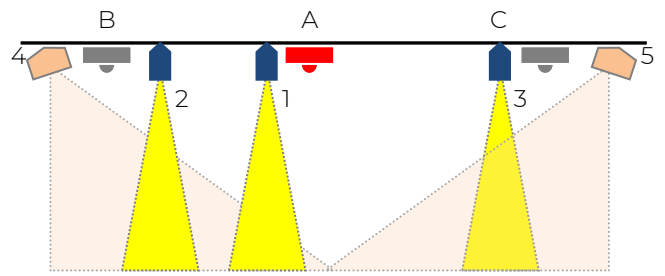
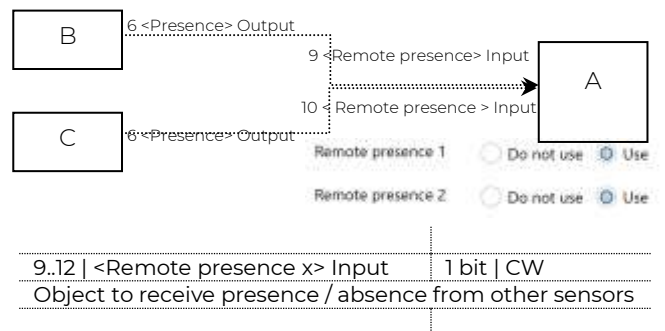

Fig. 1

In figure 1 the sensors A, B, C regulate the lamps 1,2,3 respectively. A second channel of sensor A regulates lamps 4 and 5, which must both remain on as long as presence is detected by one of the 3 sensors (A or B or C). The second channel of sensor A considers the telegrams of remote sensors B and C.



9. Use of remote presence

To use the presence information from remote sensors, the following parameters are available within the configuration page of each channel; it is necessary to have enabled and connected the communication objects as described in the previous chapter.

KNX PARAMETER	SETTINGS
Use remote presence	no/yes
Choose yes to consider data from other sensors for this channel	
Presence	do not use/use
Choose "use" to use the information of the presence channel of the device itself.	
Remote presence 1 (2.4)	do not use/use
Choose "use" to consider the presence data coming from the remote sensor 1 (2,3,4)	

10. Remote illuminance

The sensor can receive the illuminance value from other sensors and use it to obtain a weighted average. Each sensor channel has its own parameters to select which external lighting values to consider and with what weight.

It is possible to activate up to 4 remote brightness channels, for each channel the following parameters are available.

KNX PARAMETER	SETTINGS
Remote illuminance sensor	unused / used
Activates the remote brightness channel, makes a communication object visible and also the following parameters.	
Illuminance after download [*10 Lux]	0 .. 255
Defines the value that the communication object assumes after downloading, ie before valid data is received from the remote sensor.	
Correction coefficient [*0.1]	1 .. 255
Set the factor to be multiplied, expressed in hundredths, by the measured value, the value 10 is equivalent to not applying any correction value; values greater than 100 cause the received brightness value to increase (20 = double, 25 = 2.5 times; 30 = triple); values less than 100 cause the measured brightness value to decrease (5 = half, 1 = one tenth).	
Correction offset [*10 Lux]	-128 ... +127
Sets a fixed value to be added or subtracted from the measured value after applying the correction coefficient; the Offset value set is in tens of lux therefore setting the parameter to the value +10 will result in adding 100 Lux (10 * 10 = 100) to the measured value, on the contrary setting the parameter to the value -8 will result in that to subtract 80 Lux (-8 * 10 = -80) from the measured value. The value 0 is equivalent to not applying any offset.	
Correction output limits	
Minimum [*10 Lux]	0 .. 255
With this parameter you set the minimum value that the external component can take after applying the coefficient and the correction offset (the set value is multiplied by 10 Lux).	
Maximum [*100 Lux]	0 .. 255
This parameter sets the maximum value that the external component can take after applying the coefficient and the correction offset (the set value is multiplied by 100 Lux).	

11. Use of remote illuminance

To use the illuminance information from remote sensors, the following parameters are available within the configuration page of each channel; it is necessary to enable and connect the communication objects as

described in the previous chapter (function not available on the BASIC model).

13.16 | <Remote Illuminance x> Input 2 byte | CW
Object to receive Lux value from other sensors

KNX PARAMETER	SETTINGS
Usa illuminazione remota	no / yes
Choose yes to use brightness values from other sensors for this channel.	
Weight illuminance	da 1 a 15
Weight illuminance 1 remote	Do not use, da 1a 15
Weight illuminance 2 remote	
Weight illuminance 3 remote	
Weight illuminance 4 remote	
Choose "use" only if the communication object is connected, otherwise choose "do not use". It is possible to apply a different weight to each sensor to give greater importance to the value read by one sensor than another.	

Example 1:
consider the contribution of a second sensor.

To give the same weight to the value of each sensor set the parameters as:

Weight illuminance	1
Weight remote illuminance 1	1



The total weight is 2 (1+1) and each sensor weighs in equal parts: 1/2 of the total, i.e. 50%

To give one sensor twice the weight of the other, set the parameters as:

Weight illuminance	2
Weight remote illuminance 1	1



The total weight is 3 (2+1) the internal sensor weighs 2/3 of the total (66%), the external one 1/3 (33%)

Example 2:
consider the contribution of 2 other sensors.

To give the same weight to the value of each sensor set the parameters as:

Weight illuminance	1
Weight remote illuminance 1	1
Weight remote illuminance 2	1



Il peso totale è 3 (1+1+1) e ciascun sensore pesa in parti uguali: 1/3 del totale cioè pesa al 33%

Example 3:
 consider the contribution of 2 other sensors.

To give a sensor twice the weight of each of the other two, set the parameters as:

Weight illuminance	2
Weight remote illuminance 1	1
Weight remote illuminance 2	1



The total weight is 4 (2+1+1) the internal sensor weighs 2/4 of the total (50%), the remote sensors 1 and 2 weigh 1/4 each (25%)

12. Sound sensor

The MULTI and SPACE models are equipped with a sensor capable of detecting sounds and measuring their intensity. Using this sensor it is possible to send the value in decibels relative to the sound level of the room via bus: this measurement, together with those of brightness, relative humidity and temperature, is used for the control and certification of buildings (see Leed®, Breeam certifications ® and Well®).

The sound sensor is also used in environments where there are parts not visible to the infrared sensor, such as bathrooms.

Using ETS parameters and communication objects it is possible to configure actions related to the detection of sounds or, after the device has detected movement through the passive infrared sensor, it is possible to prolong the switching on of the lights also on the basis of the detected sounds.

At the end of the follow-up time, after the light has been automatically turned off, the sound sensor can listen for a set period so that the light can be reactivated by the sounds even after turned off. The sensor can be configured with different sensitivity values (from very high to very low); it is important to select the appropriate value based on the intended use of this sensor.



The sound sensor detects sounds or noises whose intensity differs from the average value of the environment in which it is located; in other words, the sensor uses an adaptation algorithm to avoid false detections if the background noise changes slowly.



The sound sensor can be enabled or disabled from the bus via a 1-bit communication object, it is therefore possible to keep it enabled at the times when you want to obtain the maximum performance of the device in terms of sensitivity and disable it when it is not necessary (for example in work environments may be active during working hours and not active in other hours).

KNX PARAMETER	SETTINGS
State after download	disabled/enabled
Defines whether the sound detection function is enabled or disabled at the end of the download, the function can also be enabled or disabled from the bus.	
Enable telegram	telegram"0"/telegram"1"
Select the value of the 1 bit telegram to enable / disable	
Sensitivity	Very high high normal low very low
Select the sensitivity of the sound sensor	
Sensitivity – day	As in the previous parameter: if the day-night switching object is enabled, it will be possible to diversify the sensitivity at different times of the day
Sensitivity - night	
Output type	off/on decibel intensity [w/m ²]
The sound sensor can be used to manage ON / OFF commands or to communicate to the supervisory systems the sound intensity value detected in dB or in W / m ²	
Telegram when sound event detected [if output type = off/on]	off/on
If the one-bit telegram is selected, this parameter defines the value of the telegram to be sent when sound is detected (start event).	
Send only detection event	no/yes
Choose "no" to send the telegram of opposite value to that of detection (end of event), at the end of the follow-up time	
Detection retention time	1 s... 2 ore
If no sound is detected the telegram related to the end of the event is sent at the end of this time.	

Correction offset [if output type = decibel]	-7 .. +7
Correction offset of the value in dB	
Sending interval	never, 1 minute ... 2 hours
Periodical sending time	
Send on variation [if output type = decibel]	never, 2 dB ... 14 dB
Value of deviation from the previous value that generates the sending of the data.	
Send on variation [if output type = Intensity]	never, $2 \cdot 10^{-9}$.. $8.19 \cdot 10^{-6}$
Value of deviation from the previous value that generates the sending of the data.	

13. Channels configuration

The device has 5 independently configurable channels, below we see the possible settings and functions, they are the same for each channel. The possible types of functions are as follows; not all functions are possible for all models, the BASIC model does not provide any function related to brightness:

- No action
- Simple presence
- Automatic presence, illuminance depending
- semi-automatic presence
- semi-automatic presence, illuminance depending
- Constant illuminance
- Constant illuminance, presence depending
- Constant illuminance, presence depending, semi-automatic

Some settings are recurring and may appear on more than one function, these settings will be described below.

Follow-up time

The follow-up time defines how long the device, after the detection of a presence, must consider the PRESENCE status valid even if it has not detected other movements. If a new movement is detected during the follow-up time, it is restarted. At the end of this time, the device goes into the ABSENCE state.

KNX PARAMETER	SETTINGS
Follow-up time	
Hours	0 .. 24

Minutes	0 .. 59
Seconds	0 .. 59

It is possible to use the information of the sound sensor to extend the follow-up time (in this case the sound is considered as a new presence detection). It is also possible to define a time at the end of the follow-up within which the detection of a sound reactivates the follow-up time even if this has expired..

KNX PARAMETER	SETTINGS
Use sound sensor event during follow-up time	no/yes
If you select yes the sound sensor will be considered for the whole follow-up time.	
Sound sensor reaction time on absence	0 .. 255 s. [0=no reaction]
At the end of the follow-up time the sensor goes into the ABSENCE state, within the time defined by this parameter it can return to PRESENCE and reactivate the follow-up time upon detection of a sound whose intensity differs from the average value of the environment in where it is.	

Objects A,B,C - presence/absence

The channels in which the behavior of the device is linked to the presence always have 3 communication objects associated with it.

The configurations of these objects are present in a dedicated page <Channel x> Outputs

<Channel x> Output A	1 bit CRT
<Channel x> Output B	1 bit CRT
<Channel x> Output C	some dpt's CRT

Objects A and B are 1-bit objects; for each of them it can be defined which telegram is linked to presence ("1" or "0") and whether the presence, absence or both telegrams must be sent.

KNX PARAMETER	SETTINGS
Output A (same parameters for Output B)	
Execute presence action	no/yes
Execute absence action	no/yes
Presence telegramma	telegram "0" / "1"
Activates the stand-by function whose parameters are configurable in a dedicated page for each channel.	

Object C can be configured with different data points: 1 byte (signed or unsigned), 2 bytes (signed or

unsigned), 2 floating bytes; in this way it is possible to use each channel to send scenario, percentage, HVAC, temperature, brightness, etc. setpoint values on the presence, absence or both events.

KNX PARAMETER	SETTINGS
Output C	
Output C - type	none 1 byte signed 1 byte unsigned 2 byte signed 2 byte unsigned 2 byte floating point
Definisce il tipo di dato da inviare sull'oggetto C	
Delay Output C	0, 100 ms, 200ms, 500 ms, 1 s, 2 s, 5 s, 10 s
Delay for sending object C respect to objects A and B.	

Stand-by function (corridor function)

The stand-by function is connected to presence detection; by activating this function the device, at the end of the follow-up time, does not turn off the lights but still keeps them on, typically at a lower brightness level to save energy but avoiding that the area remains completely in the dark.

A typical application concerns the lighting of corridors. If there are offices with an adjacent corridor it is possible to manage the corridor lighting without installing a dedicated sensor. A channel of one of the sensors located in the offices will control the corridor lights and use the sensors located in the other offices as remote sensors. When at least one of the offices is occupied the light in the corridor remains on, when instead all the offices remain empty the corridor can go into stand-by remaining with the light on at a reduced brightness level to facilitate the passage of people who have to walk through it. If the light is controlled in on / off mode with a one-bit object, it is possible to keep the light on during standby time and activate (optionally) a warning of entry into standby time with a short (1 sec.) switching off and on of the light.

KNX PARAMETER	SETTINGS
Stand-by function	disabled/enabled
Activates the stand-by function whose parameters are configurable in a dedicated page for each channel.	
Stand-by time	
Hours	0 .. 24

Minutes	0 .. 59
Seconds	0 .. 59
Output A (same parameters for Output B)	
execute warning action	no/yes
Activates the warning function for channels with 1-bit output, i.e. those channels the constant lighting function is not configured depending on presence.	
Execute Stand-by	Only for output C
Value entry field dependent on the type of data chosen for object C.	
Stand-by value	Only for channels configured with "constant illuminance"
For these channels, a value (%) of lights is usually configured to facilitate orientation, typically in the corridors.	
Sound sensor configuration	
Use sound sensor event during stand-by time	no/yes
If you select yes, the sound sensor will be considered for the whole stand-by time; if a sound is detected (intensity must differ from the average value of the environment in which it is located) sensor exits the stand-by state to return to presence.	

Lock function

The function allows to block (disable) a device channel; each channel has a communication object to activate / deactivate the block via bus. The selection of the block function enables in ETS a page dedicated to its parameters: <Channel x> Block.

KNX PARAMETER	SETTINGS
Telegram for lock activation	telegram "0" / "1"
Defines which telegram enters the device in "lock"	
Lock state after download	unlocked / locked
Assigns the status of the lock function after the ETS download is complete	
Lock state at power-on	unlocked / locked / state before power-off
Assigns the status of the block function at the end of the power-on sequence	
Automatic unlocking time	0 .. 255 [0=no automatic unlock]
It is possible to set a time after which the block function is automatically disabled	
Output behaviour when locked	Disable sensor and don't send telegram Disable sensor and send telegram

Output A (B)	nothing / off / on
Output C	nothing / value
Value	Only for output C enabled: value entry field dependent on the type of data chosen for object C.
If the "disable sensor and send telegrams" behavior is selected, it will be possible to define which telegrams and values to send before the block so that the lights controlled by the sensor can remain in the chosen state for as long as the channel is disabled.	

Stop function

The stop function is used to temporarily deactivate the sensor by changing the brightness of the environment with a manual command, for example with a KNX button or by using a sensor input.

The KNX button will be connected directly to the light actuator and the group addresses must also be connected to the sensor so that it can receive the commands that are imposed by the user on the lights.

Sensor objects to be connected to the manual control:

<Channel x> Stop 1 Bit	1 bit CW
<Channel x> Stop 4 Bit	4 bit CW
<Channel x> Stop 1 Byte	1 Byte CW

Example of connection between button, sensor and actuator: the objects that connect the button to the actuator are also connected to the sensor to give information that the command has been manually forced.

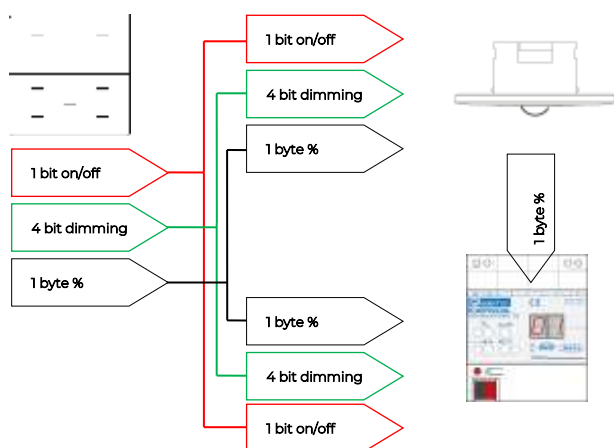

A typical application of the stop function is to force the lights to turn off in a room during a projection or to force the lights to turn on in an environment where the detected brightness is greater than the set threshold.

For as long as the device detects the presence of people, the adjustment will be disabled considering the manual selection of the user as a priority. The sensor will return to directly control the lights only at the end of the follow-up time.

It is possible to set the parameter "Automatic restart time"; it defines the duration of the sensor adjustment disabling time, when it expires the sensor resumes its automatic behavior.

These communication objects are also available:

< Channel x> Restart	1 bit CW
< Channel x> Activated/Stopped	1 bit CRT

The first CO force to exit from the stop state upon receipt of a "0" or "1" telegram; the second sends the active / stop status on the bus with telegram "0" or "1".

KNX PARAMETER	SETTINGS
Stop state after download	activated / stopped
Defines whether the device is in Stop or not after download	
Stop state after power on	activated / stopped / state before OFF
Define the status of the stop function on power-up	
Telegram for restart	telegramma "0" / "1"
Defines which telegram determines the exit of the sensor channel from the manual forcing status (stop)	
Telegram for activated	telegramma "0" / "1"
Defines which telegram is sent on the bus to indicate that the sensor channel is active again (not in stop), the opposite telegram will signal the manual forcing status (stop)	
Automatic restart time (0=unlimited) [min]	0..255
If different from zero, this parameter defines after how long the sensor channel exits the manual forcing (stop) and returns to automatic mode.	

Utilization function

Function available on product code PD00E03KNX SPACE_sensor

The **utilization function** is associated with each channel which includes the presence detection function, the function can be enabled on the channel pages. Using the **utilization function**, it is possible to calculate the percentage of time in which the presence of people in the area monitored by the sensor is detected.

An ETS parameter defines the evaluation time which can vary from 1 minute to 4 hours; it is recommended to keep monitoring time values from 5 to 60 minutes

in order to make data collection as granular as possible and leave it to the supervisor to process it. The usage data, expressed as a percentage, is sent at the end of each surveillance period using a 1 byte object. Another 1-bit object is used to force the sending of the percentage data as well as to synchronize the different sensors of the building so that the transmitted data can be compared. The ability to manage the sending of data on request is also useful for collecting data with variable frequencies throughout the day.

Occupancy FUNCTION

Function available on product code PD00E03KNX SPACE_sensor

The **occupancy function** detects data to be used to process information related to the intensity of the activity of people within the areas monitored by the sensor, this activity is proportional to the number of people present and allows you to generate a "heat map" of the areas of the buildings. The **heat map**, usually correlated to the hours of the day, identifies which areas of the buildings are used during the various hours of the day and with what intensity by providing precise information to the building manager. The analysis of the occupancy data of a building in fact highlights any planning errors of energy resources as well as possible optimizations of the use of individual and common spaces.

KNX PARAMETER	SETTINGS
Monitor function	disabled/enabled
If enabled, the sensor activates the monitoring of presence events.	
Monitor cyclic time [min]	0 .. 255 (0 = never)
Defines the sending period of the movement counter; each time the counter is restarted from zero.	

Simple presence

In this mode, the sensor acts as a simple presence detector without taking into account the contribution of the brightness sensor. There are 3 communication objects that can send data on the bus when the **presence** or **absence** condition is detected, channels A and B are 1 bit, channel C is configurable.

<Channel x> Output A	1 bit	CRT
< Channel x> Output B	1 bit	CRT

< Channel x> Output C	1 bit	CRT
	1 byte signed	
	1 byte unsigned	
	2 byte signed	
	2 byte unsigned	
2 byte float		

For channels A, B, C it is possible to set the cyclical repetition of the command; if activated the command is sent periodically, in presence and absence for all 3 objects.

Automatic presence, illuminance depending

In this mode the sensor works taking into account the contribution of the brightness sensor. The parameters, functions and communication objects are the same seen in the settings of the simple presence mode plus some specific parameters for the management of the on / off control of the light.

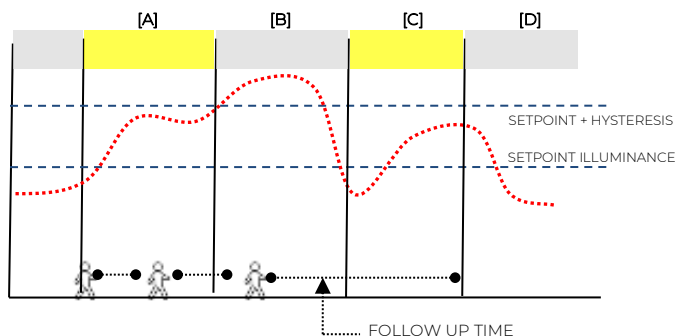

- [A] The detector identifies a movement and activates presence because the illuminance is lower than the setpoint (the light is turned on)
- [B] The illuminance exceeds the setpoint value + the hysteresis and the sensor goes into the absence state (the light is turned off)
- [C] The illuminance becomes lower than the setpoint, the presence status is still active (the light is switched on).
- [D] The FOLLOW UP time expires without any new presence detected, the sensor goes into the absence state (the light is turned off)

KNX PARAMETER	SETTINGS
Average lux algorithm	Very fast Fast Normal Slow Very slow
It defines the calculation speed of the average illuminance value, the faster the algorithm and the faster it reacts to a change in lux level. The "very fast" selection can lead to very frequent switching on and off of the light, the "very slow" selection can introduce delays in switching the light on or off.	

Upper threshold illuminance [*10 Lux]	0...255
Identifies the illuminance threshold to be set as a limit value for switching on the light when presence is detected (for higher illuminance values the light is not switched on)	
Ignore illuminance threshold on presence event	no / yes
This parameter defines whether, when detecting presence with brightness above the threshold, the sensor must turn on the light before starting the regulation (parameter = yes) or not turn on the light (parameter = no).	
Illuminance hysteresis	50..500 Lux
It defines the hysteresis band used for switching the light on and off, with values that are too low the band will be narrow and the light could be on and off more frequently.	

Semi-automatic presence

In semiautomatic modes, presence is activated by a manual command (button); the sensor receives this telegram and triggers the command to switch on the lights. There is a 1-bit object for telegram reception.

<Channel x> Command for semiautomatic	1 bit CW
---------------------------------------	------------

KNX PARAMETER	SETTINGS
Manual command activation telegram	telegram "0" / "1"
This parameter selects which telegram activates the sensor.	

Let's assume that telegram "1" is selected as the manual activation telegram; when this telegram is received, the light switches on.

If the opposite telegram ("0") is sent, the sensor:

- turns the light off if in the time elapsed between the reception of telegram "1" and telegram "0" it has not detected any presence or movement.
- ignores the telegram if in the time elapsed between the reception of telegram "1" and telegram "0" has already detected a presence or movement.
- ignores the telegram if it is the first telegram it receives (telegram "0" has not been sent previously).

The functions and parameters of this mode are the same as in the **Simple Presence** mode.

Semi-automatic presence illuminance depending

In this mode, the sensor is activated by a manual command, i.e. a 1 bit telegram which is sent on the bus and received by the sensor (see 0 Semi-automatic).

The functions and parameters of this mode are the same as those for automatic **presence illuminance depending**.

Constant illuminance

This channel is independent of presence detection and manages the constant lighting of the environment in which it is installed.

The desired lux level is set with a setpoint value that can be changed from the bus while the brightness is managed by objects with % format:

<Channel x> Illuminance setpoint	2 bytes CW
<Channel x> Output brightness Zone 1	1 byte CRT

The environment in which the detector performs constant brightness control can be divided into zones. The sensor is typically placed in the center of the room and detects the brightness at that point, the controlled environment could have greater lighting in the areas near the windows and less in the more distant areas.

Assuming that in the environment there are lights arranged in parallel rows, it is possible to group the lights of the same row up to a maximum number of 5 rows (zones).

In ETS it is defined which is the "master" zone, that is the one where the sensor is located. For each other zone it is possible to define an offset to be applied to the command calculated for the master zone. The Offset value ranges from -100% to + 100% and indicates the percentage to adjust the lighting level control. In the hypothesis that the sensor is placed in the center of the room and that the windows are on one side only (as in the figure); the areas near the windows will have a negative offset because the contribution of external light will be greater than the central area, those away from the windows will have a positive offset.

The brightness control always respects the set offset as long as the adjustment reaches the level set for the "master" zone; when the level of this zone is not sufficient then the level of all the zones is increased anyway up to bringing all the zones to 100%.

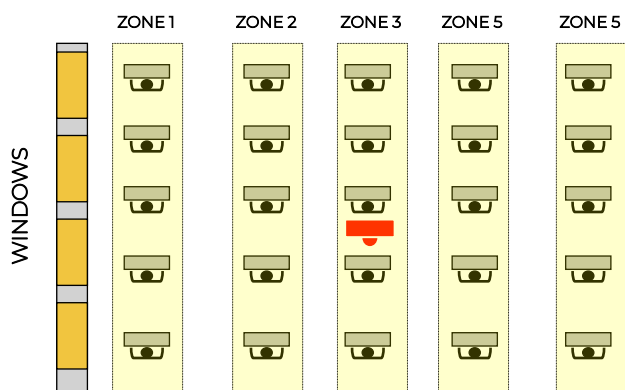

Offset management can be enabled and disabled dynamically with a 1 bit communication object.

<Channel x> illuminance setpoint 1 bit | CW

KNX PARAMETER	SETTINGS
Minimum output telegram delay	2s .. 20s
Defines the minimum time that must elapse between sending a regulation telegram and the next.	
Number of controlled zones	1 .. 5
Defines the number of zones in which to divide the controlled area.	
Zone x Offset	-100% .. +100% [x] = from 2 to 5
Defines the offset to be applied to the controls for that area (the parameter is for zones 2 to 5).	
Zone 1 minimum value	0% .. 50%
Defines the minimum value to be sent on that zone (the parameter is for zones 1 to 5)	
Zone 1 maximum value	51% .. 10%
Defines the maximum value to be sent on that zone (the parameter is for zones 1 to 5)	
Offset after download	disabled/enabled
Defines whether offset management is active after download	
Offset at power on	disabled/enabled / before power off
It defines the state of the management of the offsets at power on, it can be active / deactivate or remain in the state before the power off.	

Constant illuminance presence depending

This configuration is similar to the previous one as the sensor makes the lighting level of the controlled environment constant.

Unlike the "Constant lighting" mode, the adjustment is made only if there is a presence in the controlled

area, when the sensor goes in the absence state sets the brightness to a predetermined value (typically 0%). For this mode, the parameters already described relating to the follow-up time and the use of the sound sensor can be set (if present).

KNX PARAMETER	SETTINGS
Send initial brightness when over setpoint	no/yes
If the sensor detects presence, it can send the command to switch on the lights even if the brightness is higher than the setpoint; the adjustment algorithm will cause the lights to go out if they do not need to be on.	

Constant illuminance presence depending, semi-automatic

The channel configuration is identical to that described in the previous paragraph (Constant lighting dependent on presence)

The sensor is activated by a manual command, i.e. a 1 bit telegram which is sent on the bus and received by the sensor (see 0 Semi-automatic).

14. Digital input

With DIGITAL INPUT configuration each individual input can be configured to perform one of the following functions:

- Activation on press
- Activation on press / release
- Activation on short and long press
- Dimming
- Shutter and blinds
- Scene
- Command sequences (short and long press)
- Command sequences (toggle function)
- Command sequences 1 bit
- Set RGB color
- MUR/DND function
- Loop among values

Activation on press (closing contact)

"Activation on press" allows you to configure the sending of telegrams when the button is pressed; device can also be configured to send periodic messages with repetition period.

KNX PARAMETER	SETTINGS
Telegram Associated	1 bit / 1 byte

It is possible to send 1 bit or 1 byte objects

Configurations for 1 bit object:

- On
- Off
- Toggle

Configurations for 1 byte object:

- Value 0-255 (generic unsigned int)
- Value 0-100% (scaling value in steps of 5%)
- HVAC Mode (DPT_HVACMode 20.102)

KNX PARAMETER	SETTINGS
Cyclic sending when button pressed	Never 0.3 sec. 0.4 sec. 0.5 sec. 0.8 sec. 1.0 sec. 1.2 sec. 1.5 sec. 2.0 sec. 3.0 sec. 5.0 sec. 8.0 sec. 10 sec.
As long as the button is pressed, the telegram with selected size and value is sent cyclically; this parameter defines the time interval between two sending	

Activation on press / release (closing / opening contact)

“Activation on press / release ” allows you to configure the sending of telegrams when the button is pressed and when it is released. Parameters are identical to the choice “activation on press”; one parameter is added:

KNX PARAMETER	SETTINGS
Communication object on release	disabled / enabled
if enabled, this parameter displays an additional communication object (<Button x> Release Action) that is transmitted on the release event, this object can be associated with a group address other than the one that sends the value associated with the pressure.	

Activation on short and long press

The different duration between short and long press is defined by the parameter "Minimum time long press button".

You can set to send a telegrams with different values on short and long press or decide to send commands only on one of this events.

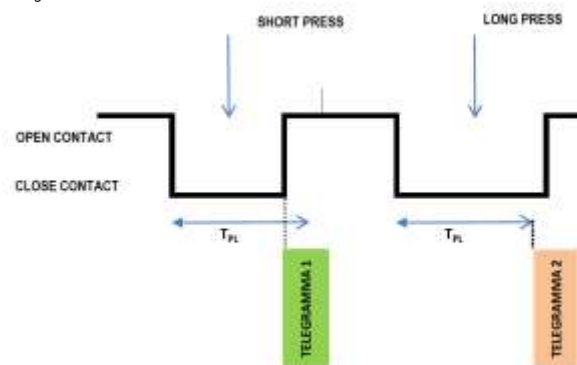

When button is pressed then counting time starts; if the button is released before time exceeds TPL time, device executes the command associated with the event of "short press" and if, on the contrary, TPL timeout expires and button is still pressed then the command associated with the event of "long press" is executed.

The parameters and mode of transmission of telegrams can be managed through "activation on long and short press" are the same set with the configuration "Activation of press / release " except for the function of cyclic sending that is not provided here.

Dimming

Through the dimming function it's possible to control a light dimmer using short and long press of the buttons.

Each button uses 2 communication objects:

- 1 bit dimension for ON /OFF command associated to short press operation
- 4 bit dimension for brightness regulation associated to long press operation

Parameter "Minimum time long press button" can set the minimum duration of long press; "Dimming mode" and "Dimming step" can define brighter or darker behaviour and step of each long press action.

Shutter and Blinds

Through the Shutter and Blind function, it's possible to control Roller Shutters or Blinds using short and long press of the buttons.

Each input uses 2 communication objects:

- 1 bit dimension for STEP / STOP command associated to short press operation
- 1 bit dimension for UP / DOWN command associated to long press operation

Parameter "Minimum time long press button" can set the minimum duration of long press; "Command drive shutter" can define up or down behavior associated to long press action.

Scene

In this configuration page it's possible to set the button for scene management: learn and recall scene commands.

These different behavior (recall and learn) are performed through two different actions (short and long press) of the button.

Learn scene on long press action is enabled by a parameter; "Minimum time long press button" can set the minimum duration of long press.

KNX PARAMETER	SETTINGS
Scene Number	Number of the scene: 0 ÷ 63
This parameter sets the value of the scene you intend to learn / recall (one per channel). Remember that output devices (i.e. actuators, etc.) generally can manage several scenes, each identified by a value (that varies from 0 to 63); therefore is important to set this parameter correctly and matching the number set on the actuators.	
Store scene on long press	disabled / enabled
If disable, long press action is ignored and no telegram is sent to the bus; if enable on long press action a learn scene telegram is sent to the bus.	
Object enable scene learning from bus	disabled / enabled
If this parameter is enabled, you have a communication object (size = 1 bit) in order to enable / disable runtime from bus the sending of the "learn scene telegram". When this object receives a telegram "1" then the function associated to the long press of the button (send the telegram storage scenario) is enabled, when it receives a telegram "0" the command associated with the long press is not sent.	

Commands sequences

This function allows you to associate to short and long press, sequences of different commands on the bus.

For each button this function is available for short and long press or as toggle function.

The sequence consists of 2 or 3 commands which can each be sized as 1 bit or 1 byte.

Once defined the number of elements in the sequence (2 or 3) and their size (1-bit / 1 byte), you can associate different commands to each element of the sequence or decide to send commands only on one of the two events.

The waiting time between a command and the next is configurable

Each object communication can be connected to a different group address.

For example, it is possible to define a sequence:

obj	dimension	short press (operation 1)	long press (operation 2)
A	1 bit	ON (to actuators)	OFF (to actuators)
B	1 byte	100% (to a dimmer)	0% (to a dimmer)
C	1 byte	COMFORT (to a thermostat)	ECONOMY (to a thermostat)

Commands sequences (1 bit)

This function allows you to send sequences of 1-bit commands to multiple objects. The sequence can be defined on 2 or 3 objects. Each time the button connected to the input is pressed, the next step of the defined sequence is sent.

KNX PARAMETER	SETTINGS
Number of objects	2, 3
This set parameter defines the number of 1-bit objects that will be visible and that will send the values 0 or 1 on the bus	
Number of steps in the sequence	2 ÷ 8
Indicates the number of steps in the sequence.	
Long press to restart sequence	disabled/enabled
Allows to associate the long action of the button connected to the input with the restart action of the sequence at step zero	
Restart function	Restart and send first step
	Send long step and restart

Restart and send first Long press determines the sending of the step 1 Send long step and restart Long press determines the sending of the next step and brings the sequence to the initial step.	
Value step Long	<Different combinations of values of a,b,c objects>
Defines what happens when long press is performed (depends on "Restart function" parameter)	
Send only changed object	disabled/enabled
This parameter defines whether, in the passage from one step to the next, all the values associated with the one-bit objects must always be sent, or only those that change.	
Value step <x>	Combinations of on and off on 2 or 3 1-bit objects
Determines the combination associated with a sequence step using 2 or 3 1-bit objects.	

Set RGB color

This function allows you to associate a short press of the button to a command on the bus in order to set an RGB color. The "RGB object type" parameter defines whether the command is sent with a single 3-byte object or 3x1-byte objects. It is also possible to enable a feature associated with a long press that allows to change the color which is sent with a short press. During long press the color transition is performed and at the time of release the selected color is stored; this means that from now every time a short press is done the new color is sent on the bus. When the device is powered off and on the last selected color is kept in memory. The "Enable sending color during transition" option allows you to send all color transitions during long press so that each color can be displayed on another device.

MUR/DND

This function allows you to configure a input to send 1-bit commands with DND (do not disturb), MUR (make up room) or reset both signals - according to the sequence described below.

Value of parameter "command associated" (column "cmd") defines which values are sent on the 2 x 1 bit objects

cmd	Action	DND	MUR	Note
MUR	enable	0	1	MUR co sends "1" DND co sends "0"
MUR	disable	-	0	MUR co sends "0"
MUR	toggle	MUR enable/disable alternate		
DND	enable	1	0	DND co sends "1" MUR co sends "0"

DND	disable	0	-	DND co sends "0"
DND	toggle	DND enable/disable alternate		
Loop		0	1	Loop among these 3 sets
		1	0	
		0	0	

It is possible to associate a color to each of the 3 states (DND active, MUR active, MUR & DND not active); it's also possible to send the same color on the bus using a 3Byte Object DPT 232.600 RGB value 3x(0..255)

Loop among values

With this function you can configure a button to send a 1-byte value in sequence. The sequence is composed of a number of values between 3 and 9. Each time a pressure (or release according to the "active edge" parameter) is done a value is sent following the order set in ETS: from the first (A) to the last (I).

Two object are available:

<Input x> Loop Value Output	1 byte – 0..255 CRT
This object is to send the values of the sequence	
< Input x> Loop Value Feedback:	1 byte – 0..255 CW
this object is to receive a value from the bus; if it corresponds to a value set in the sequence it bring the same to the corresponding step.	

15. Analog input

Input 3, if configured as an analog input for a temperature probe, can be connected to a NTC probe code eelectron:



TS01A01ACC (from -20°C to +100°C)
 TS01B01ACC (from -50°C to +60°C)

Each input can be associated with the **Temperature Probe** function or the **Thermostat** function

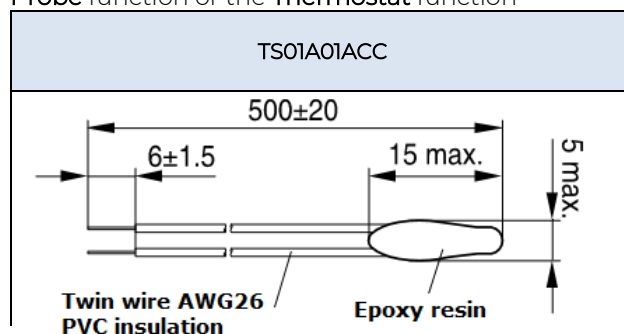

Dimensions in millimeters	
NTC resistance tolerance:	± 3%
Measure range	-20°C ÷ +100°C
Cable:	2 wire single insulation
Cable colour:	Black
NTC colour:	Black
Warning: keep at least 6 mm from all live parts	

TS01B01ACC	
D1 = 9 mm D2 = 4 mm	L2 = 49 mm L1 = 1250 mm
NTC resistance tolerance:	± 2%
Measure range	-50°C ÷ +60°C
Cable:	2 wire double insulation
Cable colour:	White
NTC colour:	White
Warning: keep at least 3 mm from all live parts	

Additional probe – description

Using the "temperature probe" module it is possible (by connecting the NTC probe) to measure the temperature and send simple ON / OFF commands. The objects available are as follows:

<Additional Probe> Temperature	2 bytes CRT
Send temperature measurement in °C on variation and / or cyclically.	
< Additional Probe> Upper Thershold	1 bit CRT
Send On, Off or nothing when the set upper threshold is raised or lowered	
< Additional Probe> Lower Thershold	1 bit CRT
Send On, Off or nothing when the set lower threshold is raised or lowered	

Additional probe – parameters

KNX PARAMETER	SETTINGS
Activation telegram	Telegram 0 Telegram 1
Defines which telegram value enables sending of the threshold on / off telegrams.	
State after download	Disabled / enabled
Defines whether the sending of the threshold on / off telegrams is enabled or disabled after download.	

Hysteresis	0.5°C 2.0°C	1.0°C 5.0°C
Defines the hysteresis value to be applied on the high and low thresholds		
Upper Setpoint value	-20°C ÷ +100°C -50°C ÷ +60°C	TS01A01ACC TS01B01ACC
Lower Setpoint value	-20°C ÷ +100°C -50°C ÷ +60°C	TS01A01ACC TS01B01ACC
Telegram when value is below setpoint	off / on / nothing	
Telegram when value is above setpoint	off / on / nothing	
Cyclic sending time of telegrams	No cyclic sending 1 hour	30 min 2 hours

16. Temperature sensor

In *General Parameter* page when setting "Temperature Function" it is possible to choose "Temperature Sensor" or "Thermostat". The temperature sensor module is similar to the "Additional probe" module; it adds some communication objects and can mix the measured temperature with an external temperature via KNX bus:

<Temperature x> Actual Temp.	2 bytes CRT
Send temperature measurement in °C on variation and / or cyclically.	
<Temperature x> KNX probe Temp.	2 bytes CW
The measurement of another probe is received via KNX	
<T.Sensor> Setpoint Upper	2 bytes CW
Receives the upper setpoint via KNX bus	
<T.Sensor> Telegram Upper	1 bit CRT
Send On, Off or nothing when going up or down the set upper threshold	
<T.Sensor> Setpoint Lower	2 bytes CW
Receives the lower setpoint via KNX bus	
< T.Sensor> Telegram Lower	1 bit CRT
Send On	
<T.Sensor> Enable Input	1 bit CW
Enables or disables the sending of on / off telegrams	

KNX probe

In *General Parameter* page when setting "Temperature Function" it is possible to choose "Temperature Sensor" or "Thermostat": in each case the page "Reference temperature" appears. In this page it is possible to enable the reading of a KNX probe that sends the measurement data to the thermostat through the communication object:

<Temperature> KNX Probe Temperature	2 Bytes CW
This object is to receive values of temperature from other devices	

Surveillance time for KNX probe (0=disabled) [min]	0..255 (min)
Whenever the thermostat receives valid data from the KNX probe, it considers this value in calculating the measured temperature and resets the internal timeout (monitoring time).	

If the KNX probe is enabled, the monitoring time is used to check whether the additional temperature sensor periodically sends valid data to the thermostat. This mechanism avoids considering valid some data that can be hours or days old as would happen if, for example, the additional sensor does not work or the thermostat cannot receive data for a long period of time.

A value for the additional sensor surveillance time must be set which is more than double the period set for the cyclical sending of the additional sensor.

17. Thermostat

The temperature function can be configured as a thermostat to control the temperature of a room or area by driving heating or cooling equipment / air conditioning fan coils / valves or through commands on / off to heating /cooling elements such as radiators, heat pumps, split, etc. ..

Thermostat operates temperature in a range from -9.9 ° C to + 99.9 ° C with 0.1°C resolution. Setpoint values (including SETPOINT MODE) from the bus are accepted in a range from 10°C to 50°C

Setpoint Settings

The control setpoint can be changed by bus in two different ways, via one of these objects:

HVAC Mode
 SETPOINT Mode

The right policy to adopt depend from the device that acts as a master, a time thermostat, a control panel or a SW supervisor. Here the list of objects for changing the active mode or setpoint value by bus.

SETPOINT Object

When "Thermostat control mode" parameter is selected with the value SETPOINT MODE, object HVAC Mode is no longer visible. Each time the thermostat receives a value on object SETPOINT MODE (2 byte size), it is used as setpoint for temperature control.

HVAC MODE obj. (switched heat / cool)

Using the HVAC MODE object (size 1 byte), it is possible to set the thermostat in one of the following modes: OFF; ECONOMY; STANDBY; COMFORT; each mode is associated with a setpoint set by an ETS parameter. OFF mode is associated with the antifreeze setpoint in heating mode and at the high temperature protection set point in cooling mode.

HVAC MODE obj. (automatic heat / cool)

Behaviour for this value of parameter "Thermostat control mode" is the same as above described but the switching from heating to cooling mode and vice versa is automatic. With this setting it is necessary to set an insensitive zone as in parameter "Dead zone".

Whenever temperature becomes greater than : $Setpoint\ comfort\ heating + (Dead\ Band / 2)$ active control is cooling; when temperature becomes less than: $Setpoint\ comfort\ cooling - (Dead\ Band / 2)$ active control is heating

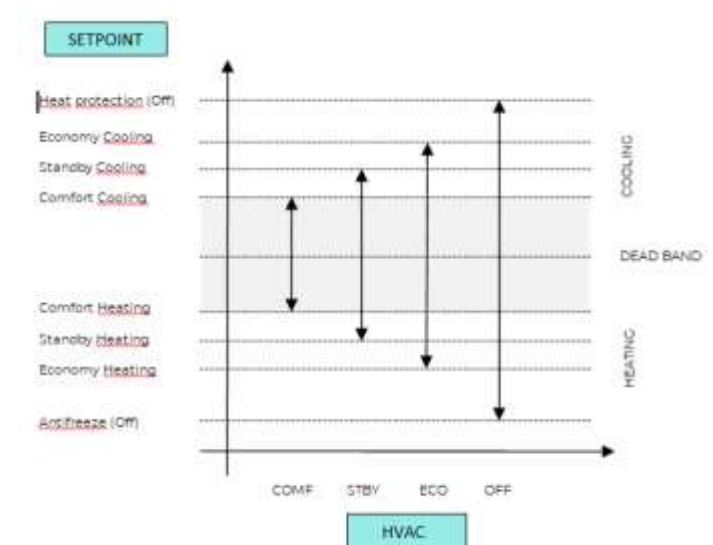

It is possible to set the comfort setpoint as the center of the dead band using the relative parameter; the comfort value is common to the heating and cooling mode.

KNX PARAMETER	SETTINGS
Comfort setpoint	Setpoint H/C Dead band center

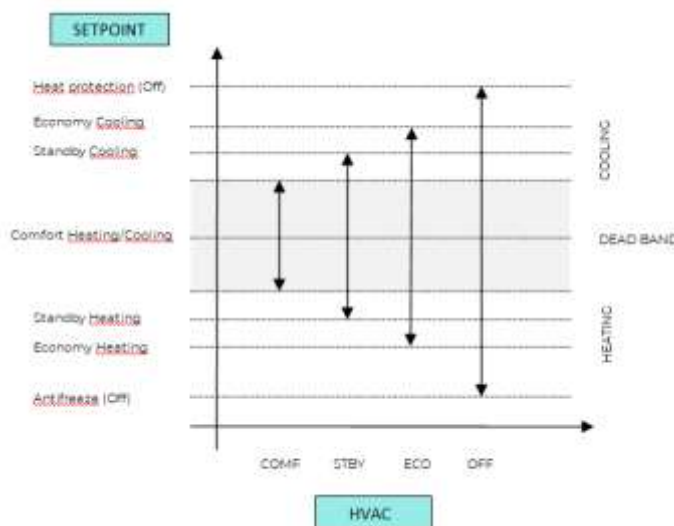

SETPOINTCOMFORT,STANDBY,ECONOMY

These 2 byte objects are used to set the setpoint values for COMFORT, STAND-BY, ECONOMY mode. Whenever change, the setpoint are in saved in memory.

After download these setpoint are reset to values according to ETS parameter; on power up these object are set according to last values before power down.

 Use these communication objects to change current setpoint for every HVAC Mode according to the current active control (heating or cooling)

KNX PARAMETER	SETTINGS
Action to execute for setpoint	modify relative modify absolute
If you set this parameter to " modify relative ", the thermostat will take into account the new value set but will still consider the setpoint set in ETS as a reference to determine the allowed variation range (± 1 , ± 2 , ± 3 , ..); choosing instead the value "absolute change" also this range will be recalculated.	

KNX PARAMETER	SETTINGS
Action to execute for setpoint	Modify Relative Modify Absolute
Modify Relative	
2 bytes Setpoint objects for mode	2 bytes Setpoint objects for adjustment
Upon receipt of a new setpoint on this object, the user adjustment is recalculated, always taking into account the limits set in the thermostat.	In this object we can find the current value of the user adjustment set in the thermostat. In the event that we want to reset the user's override, simply send 0 on that object.
If set in transmission, these objects send their actual value every time it changes	If set in transmission, the object will notify any related user adjustment on the bus
Modify absolute	
2 bytes Setpoint objects for mode	2 bytes Setpoint objects for adjustment
Upon receipt of a new setpoint on this object, the thermostat considers it as a new base setpoint	In this mode, the User Adjustment object is used to send a new current setpoint (absolute value) of the current mode to the thermostat, always taking into account the limits set in the thermostat with the parameter "adjustment allowed"
(warning, this means that the temperature limits that can be set in the thermostat are recalculated), and the user adjustment is reset	
	In transmission this object will not send anything on the bus

COMFORT Object

COMFORT object (1 bit size) is visible only when "Thermostat control mode" parameter is selected with the value HVAC MODE.

When a telegram "1" is received thermostat goes in COMFORT mode (it applies for both heating and cooling)

On receipt of a telegram "0", thermostat returns to the mode set by HVAC MODE object.

COMFORT mode can be set also with timing: after a time set by a parameter thermostat returns in the previous mode.

KNX PARAMETER	SETTINGS
Comfort Object	Time limited Time unlimited
Comfort Overwrite Time	1.. 255 (minutes)

--	--

Object ENABLE HEATING/COOLING

This object is present only in HVAC Mode automatic. If enabled, it allows you to enable or disable the heating or cooling mode.

Enable Object	Cooling / Heating
Allows you to select which mode you can enable / disable	
State after download	disabled/enabled
Determines whether after download the selected mode in the previous parameter is enabled or disabled.	
Activation telegram	telegram "0"/"1"
Telegram to enable Cooling / Heating mode.	

Object LOCK HEAT/COOL

This object is present only in automatic mode. If enabled, it allows you to lock the heating or cooling mode in the current state.

Lock Telegram	telegram "0"/telegram "1"
Telegram to block the mode.	

WINDOW CONTACT Object

This object, if enabled, has higher priority than HVAC MODE, SETPOINT MODE, COMFORT objects. When a telegram is received ("0" or "1") on the communication object WINDOW CONTACT thermostat enters a power saving mode: BUILDING PROTECTION (if running in HVAC MODE) or Setpoint antifreeze /high temperature protection (if running in SETPOINT MODE)

If the telegram received indicates that the window is opened, thermostat change its mode or setpoint after 1 minute from the reception of the telegram. When it receives a telegram corresponding to state "window closed" it restores the previous mode, always with a delay of 1 minute. The value of SETPOINT ADJUSTMENT (if enabled) is always restored.

Object THERMOSTAT OFF

Object Thermostat OFF is used to stop the Temperature controller from Bus with a 1-bit telegram.

SETPOINT ADJUSTMENT object

The object SETPOINT ADJUSTMENT allows you to temporarily change the setpoint value used by the thermostat applying an offset to the current value. If the thermostat is operating in "HVAC MODE" the offset value is applied from the time of receipt of a valid telegram on object SETPOINT ADJUSTMENT until this value does not change, even in case of change of the active mode (Comfort and Standby); when device enters Economy mode this value can be reset or not according to the parameter "Reset delta setpoint on HVAC economy). Entering Building Protection mode the value of object SETPOINT ADJUSTMENT is forced to 0. Similarly, if the thermostat is operating in SETPOINT MODE the offset value is applied also when the setpoint value received on this object changes.

ACTUAL SETPOINT object

The ACTUAL SETPOINT object send the setpoint in use and is sent every time:

- The value of HVAC mode object changes
- The value BASE SETPOINT changes
- The value of SETPOINT ADJUSTMENT object changes
- After download
- One minute after power on

Two points on/off

Control algorithm "2 points on / off" is used to control heating or cooling elements that can be controlled by switching on and off of the same elements, radiators, under floor heating with on-off valves, boilers, etc. .. When the thermostat switches to "winter mode" (heat mode) sends an off command on object ON/OFF COOLING and operates the control only through the object ON/OFF HEATING (the object ON/OFF COOLING is therefore not updated anymore until it returns in "cooling mode"). Therefore, in the transition from "winter" to "summer" mode sends an off command on ON/OFF HEATING commands and activates the control through the object ON/OFF COOLING

on/off control in heating mode:

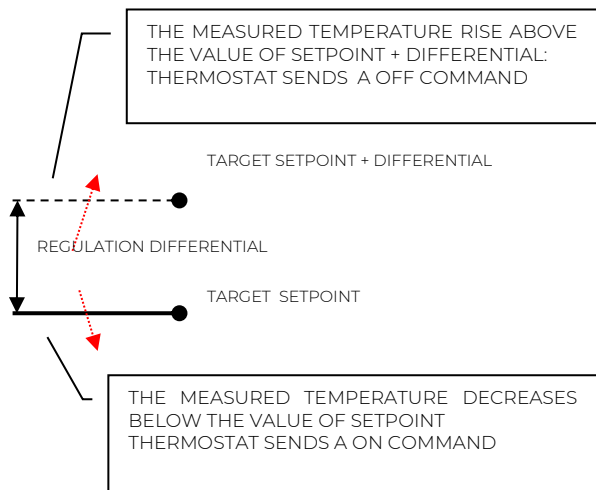

on/off control in cooling mode:

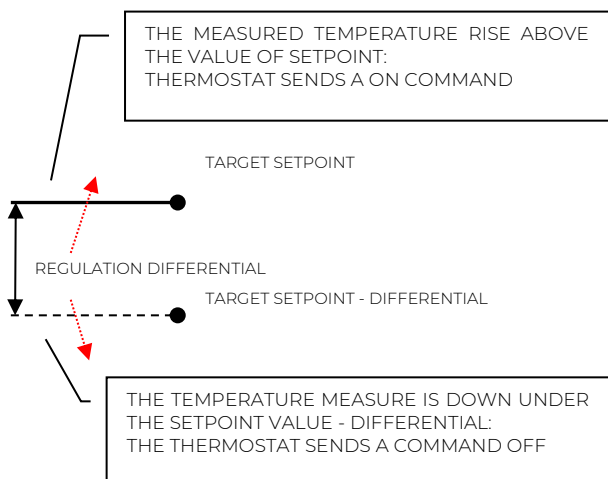

Integral proportional control PWM

Integral proportional control with PWM is an algorithm that reduces the effects of hysteresis around the set point value by adjusting the controls on the values ranging from 0% to 100% where 0% means “control off” and 100% means “maximum control action”.

Once a cycle time is defined the thermostat sets the actuator to ON for a fraction of the cycle time and OFF for the remaining part. Driving the actuator with the control value of 80% means that it is active (i.e., ON) for 80% of cycle time and OFF for the remaining 20%

KNX PARAMETER	SETTINGS
Cycle time (TCp)	10, 20, 30, 60 min
It defines the time interval.	

Proportional band (Bp)	1, 2, 3, 4, 5 °C
The proportional band BP is a range of temperatures between “Setpoint” and “Setpoint-Bp” in heating mode and between “Setpoint” and “Setpoint+Bp” in cooling mode, within this interval thermostat controls the temperature using the proportional algorithm; outside it drives actuator always in ON or OFF. When temperature is inside this range device wait the end of the cycle time before calculating the duty cycle of the next cycle. When temperature is outside of this range: below “Setpoint-Bp” in heating mode or above “Setpoint+Bp” in cooling mode it starts a new cycle as soon as temperature enters the Bp	
Integration time (Ti)	5 .. 250 min
Defines the integration time	

Integral proportional contr. continuous

This setting is very similar to “Integral proportional control with PWM” in terms of algorithm and parameters. This mode uses a 1 byte object (% value) to send the command on the bus.

Fan coil on/off

Fan coil is a device that controls the flow of cooling / heating liquid driving a valve (2-pipe fan coil) or two valves (4-pipe fan coil).

Liquid exchanges heat/cool with the environment through a ventilation system controlled by a fan. The fan is driven by an engine that typically has 3 windings that can be enabled at 3 distinct speeds.

Control logic for a 3-speeds fan coil in **heating**:

When temperature increasing:

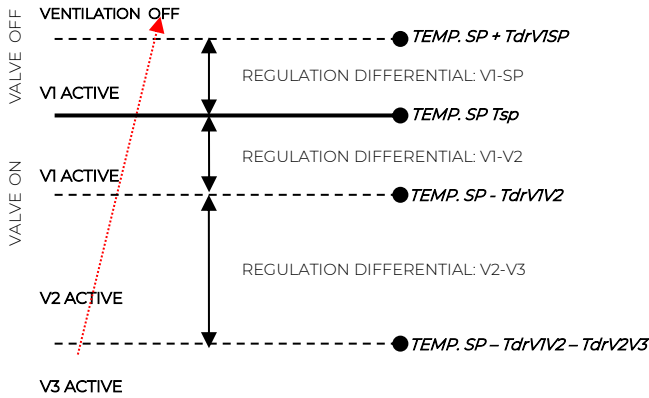

When temperature increasing

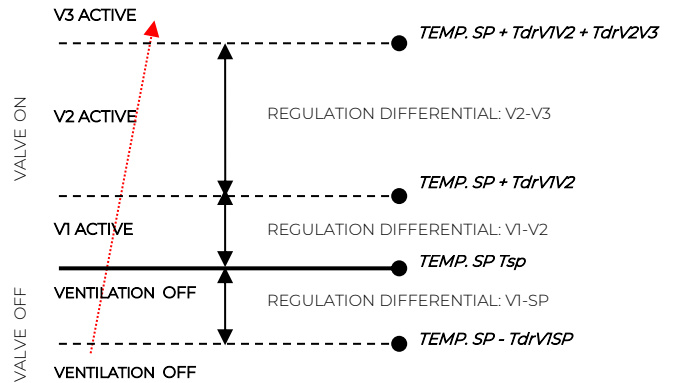

When temperature decreasing:

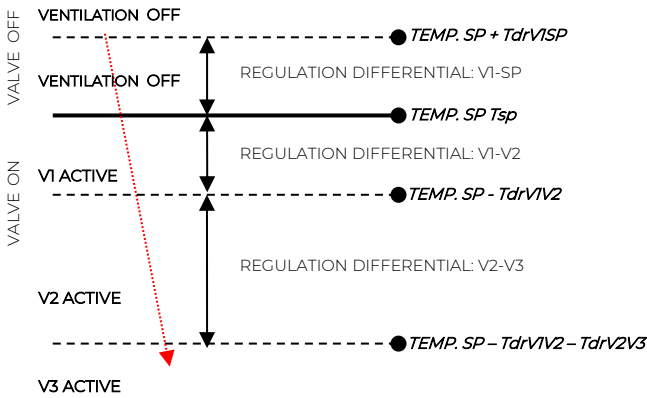

Where:

- Tsp : Target setpoint temperature
- $TdrVISp$: regulation differential in cooling for V1-SP
- $TdrVIV2$: regulation differential in cooling for V1-V2
- $TdrV2V3$: regulation differential in cooling for V2-V3

Manage valve independently

In Fan coil on / off mode it is possible to have the opening or closing of the valve independent from switching on or off the speeds by setting the parameter "manage valve independently". This makes valve adjustment differentials visible and can be set different from those set for speeds. The valve can therefore be kept open even when the fans are stopped.

Where:

- Tsp : Target setpoint temperature
- $TdrVISp$: regulation differential in heating for V1-SP
- $TdrVIV2$: regulation differential in heating for V1-V2
- $TdrV2V3$: regulation differential in heating for V2-V3

Control logic for a 3 speed fan coil in **cooling**:
 When temperature decreasing

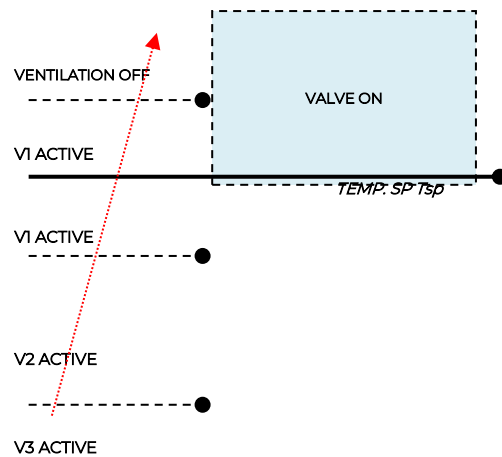
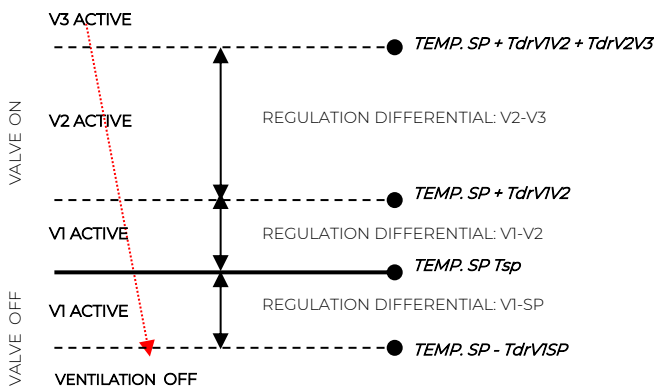

The shaded area represents the temperature range defined by the "heating control differential ON" parameter in case of increasing temperature. When the temperature decreases, the "heating control differential ON" parameter defines the valve hysteresis.

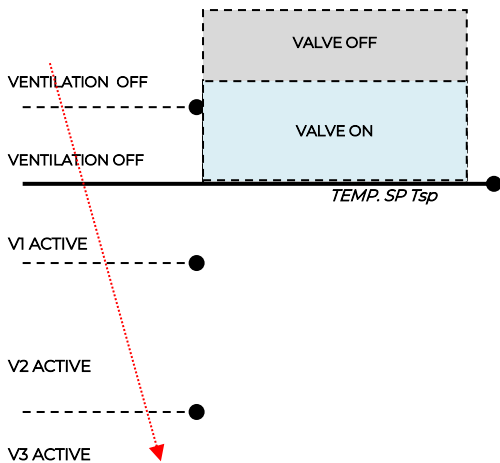

- Set parameter “Additional valve>Enable valve when” = heating
- Set parameter “Additional valve>Control algorithm” = according to your system request.

Additional valve 6 ways

The additional valve also manages commands for 6-way valves in which the control value from 0% to 100% defines both the percentage of valve opening and the passage of hot or cold fluid.

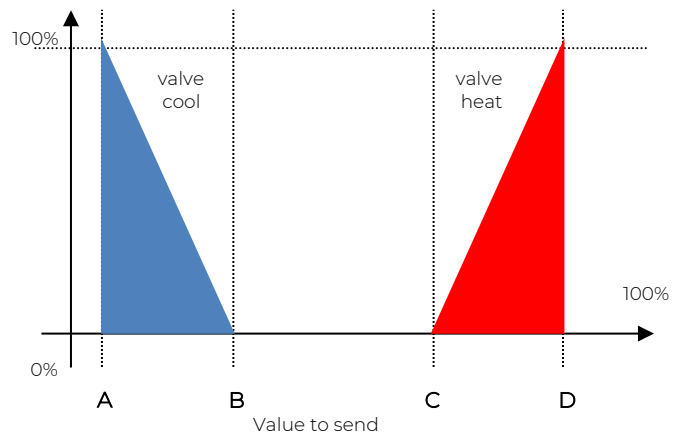

Fan coil control PI

Logic and parameters are the same used in On/off with PWM control mode; the difference is that now the proportional value is sent to the bus via a 1 byte object format as a % value from 0% to 100%.

This mode is useful to control fan coils (selecting 2 or 4 pipes) or generic proportional actuators as valve drivers only linking the 1 byte communication object and avoiding to link the valve objects.

CONTINUOUS CONTROL object

This 1 Byte object send % control value to actuator.

Additional valve



In fan coil mode it is possible, in 4 pipes systems to enable an additional valve object. This object is used when the thermostat has to manage 2 different systems, one in heating and one in cooling .

Suppose to have a system when floor heating is required in heating mode and a 3-speeds fan coil system is required in cooling mode.

To manage this system it is necessary to:

- Set parameter “Thermostat option > use thermostat to control fan coil” = yes
- Set parameter “Fan coil ON – OFF control>Enable fan speed on” or “Fan coil continuous control > Enable fan speed on” =cooling
- Set parameter “Fan coil ON – OFF control > System type” or “Fan coil continuous control > System type” = 4 pipes
- Set parameter “Enable additional valve”=enabled

KNX PARAMETER	SETTINGS
Percentage 100% cool	0% ÷ 30%
Value to be sent to bring the cold valve to 100% open position [point A on the diagram]	
Percentage 0% cool	23% ÷ 53%
Value to be sent to bring the cold valve in closed position (0% open) [point B of the diagram]	
Percentage 0% heat	47% ÷ 77%
Value to be sent to bring the hot valve to the closed position (0% open) [point C of the diagram]	
Percentage 100% heat	70% ÷ 100%
Value to be sent to bring the hot valve to 100% open position [point D on the diagram]	
Value to send for valve fully closed	36% ÷ 66%
Value to be sent to bring both the cold and hot valves to the fully closed position. [area of the diagram between B and C]	

For the additional valve, in 6-way mode, it is possible to define different control differentials around the setpoint value as shown below:

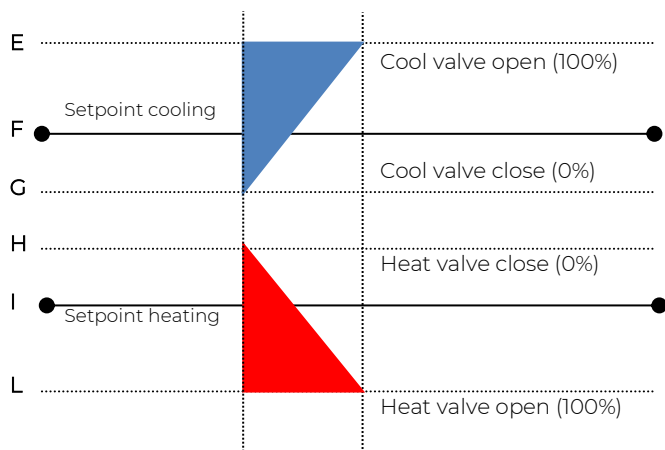

This makes it possible to adjust the opening and closing of the additional valve independently of the speed control (for example, once the setpoint has been exceeded, a maintenance action can be taken keeping the valve open again without activating the speeds)

KNX PARAMETER	SETTINGS
Regulation differential valve 0%	0°C ÷ 5 °C
Defines the width of the F-G bands for cooling and H-I for heating	
Regulation differential valve 100%	0°C ÷ 5 °C
Defines the width of the E-F bands for cooling and I-L for heating	

Force fan coil speed

In fan coil operation (in 1-bit or 1-byte mode), you can force the use of just one speed and bypass the automatic speed selection. This mode is useful, for example, in small rooms such as hotel rooms, for example or in any case where the fan speed may bring noise. To activate forcing, you must act on the 1-bit object that selects AUTO / MAN and then on the object that activates the desired speed (3x1 1-bit object or 1 object at 1-byte in% mode)

Ventilation mode

When using fan coil, you can also activate "fan" or "ventilation" mode. In this mode, the fan coil will never turn off the fan even when, after reaching the desired setpoint, the heat / cool valve closes. To select the fan speed used in ventilation mode the "force fan speed object" must be set, in fact in AUTO mode the ventilation stops when setpoint is reached. It is also possible to make the "ventilation" mode always active without having to turn it on / off via a communication object.

2nd Stage Object

The 2nd Stage object is an additional control object for the regulation of a second heating or cooling equipment; a 1-bit or 1-byte control can be set for this object; if the control is a byte it is possible to set PI control (Proportional Integral). With the "Bandwidth" parameter you set how much the current setpoint is shifted to manage the switching on and off of the equipment controlled by the 2nd stage object. For example, if the setpoint is 20 ° C and "Bandwidth" is set = 1 then the setpoint for the part controlled by the 2nd stage object will be 20-1 = 19 ° C; vice versa if "Bandwidth" is = -1 then the 2nd stage setpoint will be 20 - (- 1) = 20 + 1 = 21 ° C.



If the equipment controlled by 2nd Stage is a 1,2 or 3-speed fan coil it is suggested to set the 2nd stage as 1 Byte and to send the control value % in the logic called "proportional speed/fancoil conversion" to have 1 bit output objects for the 3 speeds.

Temperature probe failure / out of range measurement



If the temperature probe is disconnected or in short circuit the control action is interrupted and the controlled actuators are switched off.



The value of temperature sent on the bus in case of probe disconnection or short circuit or for out of range measured value is 0 ° C (according to KNX DPT_Value_Temp 9.001)

Temperature alarm object

Alarm objects are available for each thermostat and for each temperature probe; in case of probe failure or out of range measurement, a telegram with value "1" is sent to the bus on a 1-bit communication object; as soon as the temperature sensor is operating again, the value "0" is transmitted.

To correctly manage the internal or rear sensor or KNX sensor via bus, refer to the following configuration modes:

CONFIGURATION MODE 1
Probe connected to input 3
if the temperature probe is disconnected or short-circuited, the monitoring action is interrupted, and the controlled actuators are deactivated.
probe / short circuit disconnection / out of range measurement:
Obj "Temperature" is not send
Obj "Alarm" send "1"

CONFIGURATION MODE 2
Only KNX temperature via bus
The KNX probe is read considering the last value received on the Obj "KNX probe temperature".
If the KNX probe value is out of range or the monitoring time expires: Obj "Alarm" send "1" until KNX temperature is received again.

CONFIGURATION MODE 3
Mix of probe connected to input and KNX temperature via bus
The KNX probe is read by considering the last value received on the OBJ "KNX temperature probe".
The value of the temperature sent on the bus is the weighted average between the values of the front probe and KNX.
If the value of the KNX probe is out of range or the monitoring time expires without having received any message, the thermostat starts by considering only the other probe until it receives a new valid value from the KNX probe; in this case the bus value is again considered.

CONFIGURATION MODE 4
Probe connected to input 3 with smart sensor SM03E01ACC
if the smart sensor is disconnected or it's impossible to establish any communication between Smart sensor and presence sensor then:
Obj "Temperature" is not send Obj "Alarm" send "1"

18. Thermostat behavior on bus failure, recovery and download

Behavior on bus voltage failure

On failure of bus voltage no actions are executed by the device; behavior of controlled actuators must be set using their own parameters.

Behavior on bus voltage recovery

On bus voltage recovery all the communication objects are set to 0 except for objects for which a parameter is defined for the initial value; thermostat keeps these values in memory and restore them after recovery:

- Heat / Cool mode
- HVAC Mode
- Base Setpoint
- Setpoint Adjustment

- Force value in manual mode
- Ventilation

Control values (i.e. commands to actuators) are calculated using actual setpoint and temperature.



After power on device recalculates the commands to actuators and switch them on, if necessary, otherwise does not carry out any action; you are recommended to set the behaviour of actuator in order to switch the heating / cooling equipment off after bus power on.

Behaviour on ETS Download

After download it's possible to set initial value of:

- Heat / Cool mode
- HVAC Mode
- Ventilation

For other communications objects the behavior is identical to bus voltage recovery.

Wrong application download

If the wrong ETS application is downloaded, then KNX/EIB led starts blinking and device is not operative on the bus. A power reset must be done or the correct ETS application must be downloaded.

19. Logics

The logic functions are organized into groups of 3 objects: 2 inputs and 1 output, except the one called "logic expression" that will be described later. The scheme of logics is as follows:

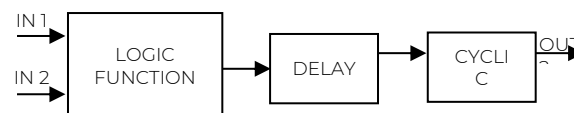

Inputs

Input datatypes can be bit, byte, float etc according to the selected logic.

IN1 is always present. IN2 maybe unused (or hidden directly by ETS).

Delay

The logic output can be delayed according to the ETS parameter, if a new value is received, the output is overwritten and the delay reset.

Cyclic

The delayed output can be retransmitted n times according to ETS parameters

Logic function

Logic function type is defined by an ETS parameter; here the list of functions:

FUNCTION NAME	DESCRIPTION
Disabled	The logic block is disabled, no parameter / object is visible.
bit no transfer	Only delay and retransmission. IN1 is a bit. IN2 is disabled. OUT is a bit.
byte no transfer	Only delay and retransmission. IN1 is a byte. IN2 is disabled. OUT is a byte.
bit NOT	OUT = NOT IN1 IN1 is a bit. IN2 is disabled. OUT is a bit.
bit AND	OUT = IN1 AND IN2 IN1 is a bit IN2 is a bit OUT is a bit.
bit OR	OUT = IN1 OR IN2 IN1 is a bit IN2 is a bit OUT is a bit.
bit NAND	OUT = NOT (IN1 AND IN2) IN1 is a bit IN2 is a bit OUT is a bit.
bit NOR	OUT = NOT (IN1 OR IN2) IN1 is a bit IN2 is a bit OUT is a bit.
bit XOR	OUT = IN1 XOR IN2 IN1 is a bit IN2 is a bit OUT is a bit.
bit XNOR	OUT = NOT (IN1 XOR IN2) IN1 is a bit IN2 is a bit OUT is a bit.
bit to byte conversion	2 ETS parameters: BYTE_0, BYTE_1. When 0 is received, BYTE_0 is sent. When 1 is received, BYTE_1 is sent. IN1 is a bit. IN2 is disabled. OUT is a byte.
byte to bit conversion	1 ETS parameter: BYTE_V. When a value equal to BYTE_V is received then a telegram 0,1, or nothing is sent. When a value different from BYTE_V is received then a telegram 0,1, or nothing is sent IN1 is a byte. IN2 is disabled. OUT is a bit.
byte threshold	1 ETS parameter: BYTE_V. When a value less or equal to BYTE_V is received then a telegram 0,1, or nothing is sent. When a value greater than BYTE_V is received then a telegram 0,1, or nothing is sent IN1 is a byte. IN2 is disabled. OUT is a bit.
2 byte float threshold	1 ETS parameter: 2BYTE_F.

	When a value less or equal to 2BYTE_F is received then a telegram 0,1, or nothing is sent. When a value greater than 2BYTE_F is received then a telegram 0,1, or nothing is sent IN1 is a 2 bytes float. IN2 is disabled. OUT is a bit.
4 byte float threshold	1 ETS parameter: 4BYTE_F. When a value less or equal to 4BYTE_F is received then a telegram 0,1, or nothing is sent. When a value greater than 4BYTE_F is received then a telegram 0,1, or nothing is sent IN1 is a 4 bytes float. IN2 is disabled. OUT is a bit.
proportional fancoil	This logic is to have a thermostat where you can set Temperature, Setpoint and Mode (Heat or Cool) and it calculates the output value % and send it on the bus with 1 Byte Object. Parameters are: Dead Band; Proportional band; control type (P or PI); system type (1 valve or 2 valves)
proportional / speed fancoil conversion	This logic is to convert a 1 byte value % (given by a thermostat) into a 3x1 bit object speed control value to manage fan coils. By setting the parameter "proportional conversion" it can be also a conversion from 3x1-bit object speed into a 1 byte object value %
dew point humidistat	This logic is to calculate the dew point given relative humidity , temperature,
surveillance	This logic allows to monitor an object via BUS via a status object and send an alarm telegram in case of non-reception.
expression	See next paragraph

Expression

Logic expression can be used to implement custom logic and arithmetic operation between values received on the KNX bus.

The logic expression has 5 objects: 4 inputs and 1 output. The scheme of logic expression is as follows:

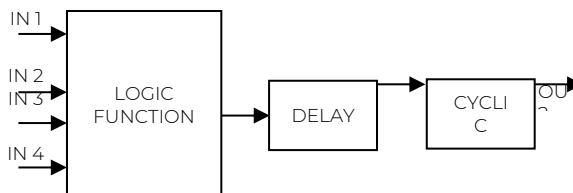

Inputs (A, B, C, D) and output (OUT) objects

The datapoints can be configured through an ETS parameter:

- bit
- unsigned byte
- signed byte
- unsigned 2 bytes
- signed 2 bytes
- float 2 bytes (eg. temperature, humidity, ...)
- unsigned 4 bytes

- signed 4 bytes
- float 4 bytes (eg. power, energy, ...)

Expression

Configurable through an ETS parameter of 16 (maximum) character string. The output of the logic is the arithmetic evaluation of this expression. Inputs objects can be accessed through their letters (A, B, C, D), the result is sent to the delay block.

Permitted operands:

"+"	arithmetic sum
"_"	arithmetic subtraction
"*"	arithmetic multiplication
"/"	arithmetic division
"&"	logic AND
" "	logic OR
"^"	logic XOR
"!"	logic NOT
">"	greater than
"<"	less than
"="	equal to
"?" " :"	ternary conditional
"(" and ")"	grouping operands

Ternary conditional:

<condition> ? <expression1> : <expression2>

Where:

condition is the expression to be evaluated.
expression1 is evaluated when *condition* is TRUE
expression2 is evaluated when *condition* is FALSE
expression1 or *expression2* can be "N" when "no expression has to be evaluated"

Expression examples:

"(A+B+C)/3"	calculate the mean of the A, B, C objects
"A*9/5+32"	convert object A Celsius degrees to Fahrenheit degrees
"A*1000"	convert object A KW to W
"A*3.6"	convert object A m/s to Km/h

- Quotation marks must not be included in expressions
- If wrong or unrecognized characters are used in expression then it will be not processed and discarded..

20. Circadian rhythm function

The circadian rhythm function allows you to perform continuous color temperature control with lamps that manage the color temperature or, more simply, the Warm and Cold components of the white light. This management is called HCL (Human Centric Light). This function is available on the devices in the STANDARD, HIGH BAY, MULTI and SPACE versions.

The working principle

The principle of HCL lighting management is to provide human-friendly room lighting that differs according to the time of day: the mix of warm and cold light (dynamic white) must follow the biological rhythm of the people who live or work in the rooms.

Pratically

The sensor uses the date and time information that must be provided by bus; using this information, the sensor imposes, based on the parameters chosen by the user, the color temperature of the lamps considering the contribution of natural external light entering the room and the current time, practically which point is now in the circadian cycle. The following parameters are present in the "General Parameters" page

KNX PARAMETER	SETTINGS
Date Time Format	DateTime (1x8 Bytes) Date and Time (2x3 Bytes)
Defines the desired format for updating the date and time on the sensor.	
Timezone is	GMT + Offset GMT - Offset
Timezone Offset hours	0 .. 11
Timezone Offset minutes	0, 15, 30, 45
These 3 parameters define the time zone in which you are located (including any offsets <1 hour); as we will see later, the correct setting of this parameter also allows you to manage on / off events associated with sunrise and sunset times for a certain date in a certain position on the globe (Astronomical clock).	
Request time on power ON	no / yes
Forces the sensor to request the day / hour data on the bus after a restart.	

On the ETS page called "Circadian Rhythm" and in its subpages you can set the parameters of the light control.

The first selection to be made requires the choice between "normal circadian rhythm" and "forced circadian rhythm".

Some parameters are common to the 2 modes such as:

KNX PARAMETER	SETTINGS
Elevation curve	wide/fast normal narrow/slow
Defines the duration of the transition phases between sunrise-noon-sunset, wide/fast curve refers to a fast transition; narrow/slow curve refers to a slow transition.	
Output mode	warm/cool lamp RGB R+G+B

warm/cold lamp: use when lamps have 2 different ballasts, 1 per component. RGB: use when the lamps can manage 1 single command that imposes the color temperature. R + G + B: use when the lamp manages the 3 R+G+B components as separated	
Output cyclic send time	from 0 to 2 h
Defines whether there is a cyclical sending to impose light on the lamp	
Output send on variation	from <1% to 7%
Defines what is the minimum difference in brightness that triggers the setting of a new value for the lamp	

The **normal circadian rhythm** requires to enter in ETS data relating to the position of the terrestrial globe (latitude and longitude) whose light conditions are to be simulated. You can directly enter the coordinates (expert mode) or use the simplified setting mode; for example, if you want to recreate the light conditions present at the equator in a different place (for example Legnano (MI) - Italy) you will choose Latitude = "equator" and Longitude = 8.92 (the longitude of Legnano).

KNX PARAMETER	SETTINGS
Latitude	Equator Tropic of Cancer Tropic of Capricorn expert
Select a standard latitude or a location of your choice	
Longitude	-90 .. +90
Select the longitude of the place where the device is commissioned	
Telegram for Daylight Saving Time activation	telegram "0" / "1"
The change from summer time to solar time and vice versa is imposed with a 1 bit telegram.	
Daylight Saving Time after download	not active / active
Daylight Saving Time shift [*10min]	1..12
These parameters define the use of summer time if present.	
Telegram for sunrise event	telegram "0" / "1"
Sunrise event time adjustment [min]	-128 ... +127
Sunset event time adjustment [min]	-128 ... +127
These parameters define the actions related to the sunrise and sunset events and the relative deviation (typical application: garden lights on / off)	

The **forced circadian rhythm** requires to enter in ETS data relating to the duration and composition of an ideal day: a forced day. The forced rhythm repeats the same day / night cycle in the same way, this cycle can also have a duration different from 24 hours and the duration of the day and night are freely configurable.

KNX PARAMETER	SETTINGS
Restart day telegram	telegram "0" / "1"
The forced day restart can be triggered with a 1 bit telegram, with the value "0" or "1"	
Restart automatically	no / yes
Choosing "yes" at the end of the forced day a new forced day is restarted	
Day duration: hours	0 .. 31
Day duration: minutes	0 .. 59
Sunrise : hours	0 .. 31
Sunrise. minutes	0 .. 59
Sunset : hours	0 .. 31
Sunset: minutes	0 .. 59
Current time after download hour	0 .. 31
Current time after download minutes	0 .. 59
With the parameters listed above you set the duration of the forced day and the time of sunrise and sunset	

Set color temperature

The color temperature control must be done taking into account the type of lighting fixtures that are going to be controlled and the characteristics of warm white and cold white which can be different from lamp to lamp.

KNX PARAMETER	SETTINGS
Warm (minimum) color temperature	500 .. 3500
Cool (maximum) color temperature	3500 .. 6500
Forced color temperature after download	500 .. 6500
These parameters set the characteristics of the lamp (check the lamp datasheet) and the color temperature value at download.	
Maximum negative color adjustment [*10K]	0 .. 255
Massima variazione positiva di colore [*10K]	0..255
Color adjustment after download	-127 .. +128
These parameters set the limits of manual adjustment that can be made on the color temperature with a 4-bit dimming object.	
Telegram for automatic color temperature	telegram "0" / "1"
Defines the value of the 1-bit telegram which changes the color temperature control from manual to automatic (the opposite value set the manual control)	

Reset color temperature adjustment on enable/disable change	no / yes
Reset color temperature adjustment on auto/manual change	no / yes
Color temperature adjustment reset telegram	telegram "0" / "1"
These parameters define whether the manual variation imposed on the color temperature should be maintained or not.	

Set brightness

As for the color temperature, parameters are available for setting the brightness, intended as a percentage control value of the lighting fixtures.

Similarly to what was previously seen, for the color temperature it is possible to set minimum (sunrise) and maximum (noon) brightness values; apply manual changes to the set value, switch from automatic to manual control.

21. Virtual holder

Virtual holder is activated by enabling corresponded parameter in page "General Settings".

The application field is typically the hotel room where, by using this feature, you can remove the Holder for access control.

This logical module provides a set of parameters and communication objects that, suitably configured, allow you to set up whether or not a person is occupying the room.

Definitions:

VH = Virtual Holder

CO = Communication Object

IN = CO receiving telegram from the bus

OUT = CO sending telegram on the bus

Welcome = event triggered when someone enters the room which was not occupied

Goodbye = event triggered when the room goes in status "unoccupied"

How it works

When one or more people enter the room, that event is recognized by the door opening and if, after it is closed, the customer's presence is still identified, then the logical module decides that the client is in the room otherwise it determines that he is out of the room. The minimum set of sensor requested for this logic to work properly is:

- one door contact for each door of the room, this contact must be detected by a KNX device in order to send on the bus the value "0" when door is closed and value 1 when door is opened

- at least one presence detector for each area; this presence detector can be KNX or conventional with dry contact output to be connected a KNX input. This device must send on the bus the value "1" when presence is detected and value 0 when presence is not detected.

Communication Objects

<VH> Room Booked	IN	1 bit
By setting this CO to "1" the status of the VH is set to "room booked"; when set to "0" the status is "room not booked". The VH module can have different behaviour if the room is booked or not; default value for this status can be set using the "Booked state after download" parameter.		
<VH> Signal for guest (Type1)	IN	1 bit
<VH> Signal for service (Type2)	IN	1 bit
<VH> Signal for maintenance (Type3)	IN	1 bit
This COs can be used to communicate to the VH module who is entering the room. This can be achieved by using a KNX Access Control Reader (<i>Synchronicity</i> by eelectron) or by interfacing other access systems with KNX bus		
<VH> Presence for guest (Type1)	OUT	1 bit
<VH> Presence for service (Type2)	OUT	1 bit
<VH> Presence for maintenance (Type3)	OUT	1 bit
This COs can be used to send from VH module information about who entered the room to a supervisor or similar sw.		
<VH> Remote Inputs Enabled (Global Enable)	IN	1 bit
See paragraph Remote Sensor inputs (Global Enable).		
<VH> Presence Output	OUT	1 bit
This CO send "1" when someone is detected inside the room (presence) and "0" when nobody is detected inside the room and the "presence wait time" has expired (absence).		
<VH> HVAC Output	OUT	1 byte
This CO is used to send HVAC commands in event of presence and absence. Commands can be set different if the room is booked or not and if the person who enter the room is guest, service or maintenance.		
<VH> Additional Output	OUT	1 byte
This CO is used to send commands in event of presence and absence. Commands can be set different if the room is booked or not and if the person who enter the room is guest, service or maintenance.		

Parameters – General

KNX PARAMETER	SETTINGS
Presence wait time	1 min to 3 hours
This parameter set the "wait time" for the VH module. The "wait time" is the time triggered by the opening and consequent closing of the door. During this time the room is in "wait" mode and after this can go in "occupied" or "non occupiaed" status.	

Use values for this parameter that are not too small to avoid not recognizing people in the room and not too big to avoid to keep room service active for too long after customers leave.	
Cyclic presence send time	No cyclic send, 1 min to 1 hour
Object <VH> Presence Output can be send cyclically if this parameter is set different from "No cyclic send".	
Presence sensor OFF latency	10 to 63 sec.
This parameter is related to the time set on the presence detector. The most of presence detectors keep the presence status for a configurable amount of seconds; set this parameter to the same value. It's recommended to set this time duration at the minimum. If the presence detector is a conventional one (dry contact output connected to a KNX input) this time duration is the relay time. If the knob of the conventional presence detector is set to 10 sec. then set this parameter to 10 sec. as well.	
Send welcome on unexpected presence	do not send / send
This parameter defines the behavior when the VH module detects a presence inside the room and is in "not occupied" status (unexpected presence). It's possible to send or not the welcome event.	
Global enable state after download	disabled / enabled
See paragraph Remote Sensor inputs (Global Enable).	
Booked status after download	not booked / booked
Set the initial value for the object <VH> Room Booked	
Absence with door open (deny=if door open presence is active)	allow / deny
This parameter defines the behavior when the VH module detects the open port. If the door remains open longer than the wait time, this parameter defines whether to keep the room in "occupied" state or not.	
Additional output type	value 0-255 value 0-100% scene
It is possible to enable an additional CO to transmit on the bus a command linked to presence or absence events.	

Parameters – Remote inputs

In this page the installer must set which type of sensor are linked to the VH module

KNX PARAMETER	SETTINGS
Remote input <x>	disabled door presence bus sniffer
disabled: non used door: set this option if the communication object <VH> Remote Input x Door is linked to a door contact KNX input.	

presence: set this option if the communication object <VH> Remote Input x Presence is linked to a presence detector KNX communication object. Bus sniffer: set this option if the communication object <VH> Remote Input x Sniffer is linked to a generic CO used in the room.	
	Usage of the Bus Sniffer Option. When a person occupies a room interacts with it. Turning on or off a light in the main room or in the bathroom gives indication of the presence of people inside the room. To reduce the risk of not correctly identifying the "occupied room" status, it is recommended to connect a "bus sniffer" input to all the 1 bit objects that can be sent to the bus only by the presence of a person in the room such as bathroom or mirror lights or window contact or bedside light, etc ...
	WARNING ON REMOTE INPUT <X> CO - a Remote Input CO (type door) must be connected only to one single door contact on/off telegram; - a Remote Input CO (type presence) must be connected only to one single device with presence on/off telegram; - a Remote Input CO (type bus sniffer) can be connected to more than one devices.
Local input	disabled door presence
Local input can be connected either to a door contact or conventional presence detector ; by setting this input as "digital input" and "activation press/release" it's possible to send also telegram on the KNX bus for other purposes.	

Remote Sensor Inputs (Global Enable)

This CO is used when you need to consider 2 adjacent rooms as separated or joined as if they were a single room (suite room).

This possibility must be considered during installation, so communication objects must be connected as described below if you want to switch runtime from one configuration (2 single rooms) to another (one double room) and vice versa.

To handle this situation both "Virtual Holder" modules of the 2 single rooms must be activated and configured.

The principle is to connect the sensors (door, presence and sniffer) of room 1 to room 2 and vice versa; however, the "Subordinate to Remote Inputs Enable" parameter for each single Remote Input should be properly configured.

For sensors located in Room 1, this parameter must be set to "not subordinate" on room 1 "Virtual Holder" while should be "subordinated" to room 2 Virtual Holder

The same principle must be applied to room 2 sensors that are "subordinate" only for the connections to room 1.

Setting the value "1" on the "Remote Inputs Enable" object for the "Virtual Holder" of each room each module will consider all sensors connected to it; by setting this CO to "0" each "Virtual Holder" only

considers the sensors connected to its "remote inputs" set as "not subordinate"
For a connection diagram of this function see Fig. 2.

DIAGRAM OF LOGICAL CONNECTIONS FOR VIRTUAL HOLDER LOGIC MODULE

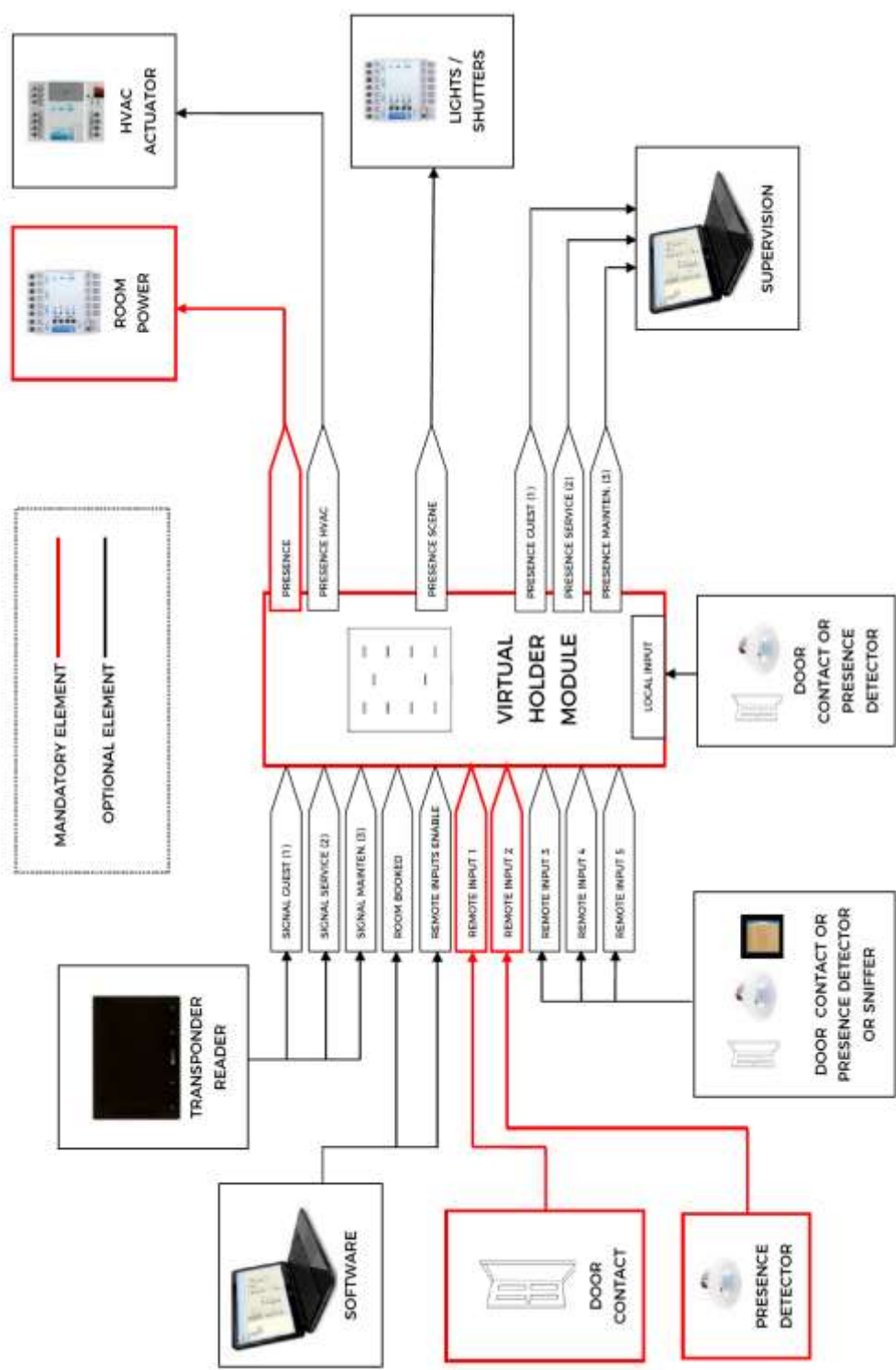

FIG.1

DIAGRAM OF LOGICAL CONNECTIONS FOR REMOTE SENSOR INPUT ENABLE
 (GLOBAL ENABLE)

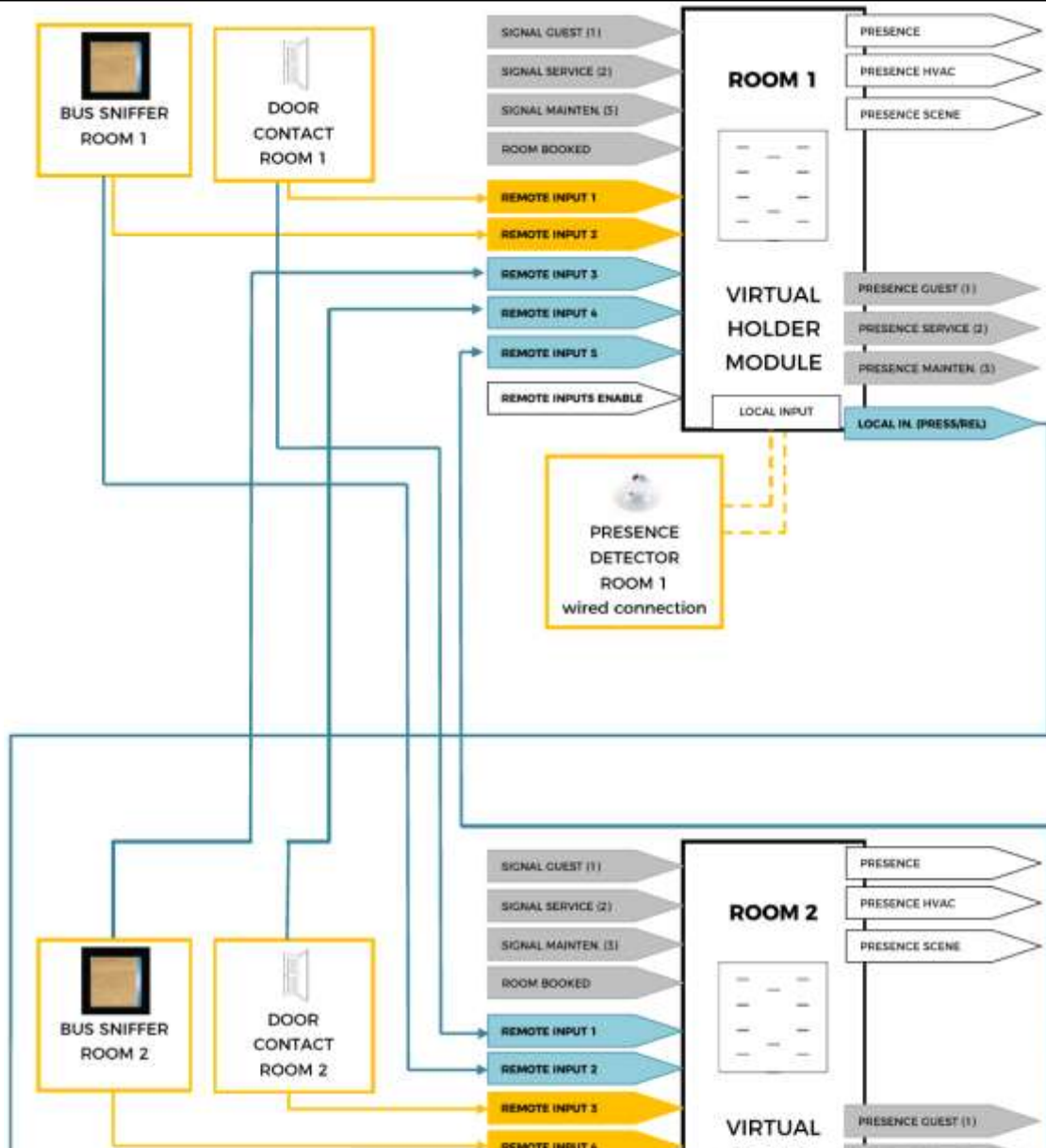

FIG. 2

